



CAIXAS EMPILHÁVEIS E ENCAIXÁVEIS

Série 9000

Caixas Fechadas



Ref.	Dim. ext.	Cap.	Quant./paleta
9801_	600x400x400mm	70L	90/ 
9751_	600x400x300mm	50L	130/ 
9701_	600x400x200mm	35L	190/ 
9901_	600x400x150mm	25L	195/ 

Empilháveis, e também encaixáveis umas nas outras para economia de espaço, bastando dar meia volta à caixa de cima para encaixar em vez de empilhar na de baixo.

As pegas com aberturas facilitam o manuseamento das caixas.

A **Tampa Ref. 3006_** permite a colocação de cintas de inviolabilidade.





Ref. 3006_
(600 x 400 mm)

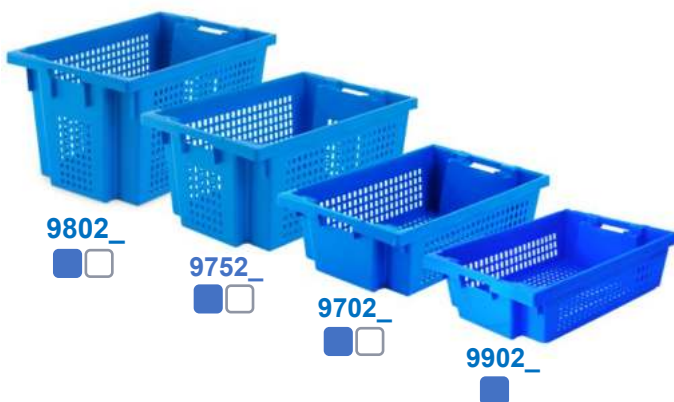

Ref. 9654_
Base com rodízios
(600 x 400 mm)

Caixas Gradeadas



Ref.	Dim. ext.	Cap.	Quant./paleta
9802_	600x400x400mm	70L	90/ 
9752_	600x400x300mm	50L	130/ 
9702_	600x400x200mm	35L	190/ 
9902_	600x400x150mm	25L	195/ 



Ref. 9656_
Base com rodízios
(600 x 400 mm)

Por encomenda podem fabricar-se:

- com lados gradeados e fundo fechado, ou:
- com lados fechados e fundo gradeado, ou:
- com rodízios, lados e fundo gradeados (Ref. 990R, 970R, e 980R), ou:
- com rodízios, lados fechados e fundo gradeado.



980R_

CAIXAS EMPILHÁVEIS E ENCAIXÁVEIS Série 9000

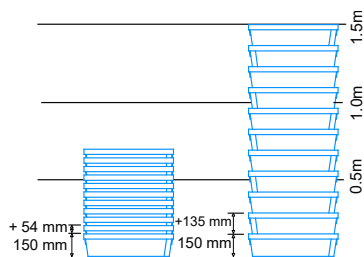

Ref. 990_ _
(ext.) 600x400x150mm
(int.) 490x332x145mm
25L



Ref. 970_ _
(ext.) 600x400x200mm
(int.) 490x332x195mm
35L

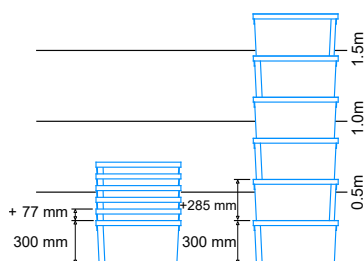
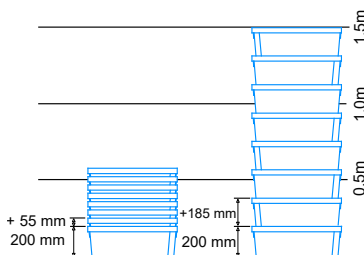

Ref. 975_ _
(ext.) 600x400x300mm
(int.) 490x332x295mm
50L



Ref. 980_ _
(ext.) 600x400x400mm
(int.) 490x332x395mm
70L

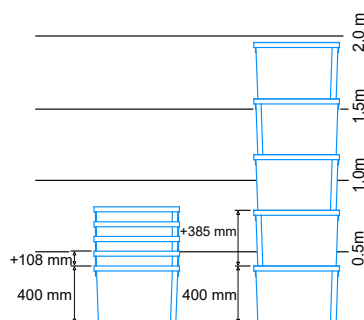

Por encomenda podem fabricar-se:

- com lados gradeados e fundo fechado, ou:
- com lados fechados e fundo gradeado, ou:
- com rodízios, lados e fundo gradeados (Ref. 990R, 970R, e 980R), ou:
- com rodízios, lados fechados e fundo gradeado.

CAIXAS PARA VINDIMA



As caixas são empilháveis. Pode empilhar várias caixas sem esmagar as uvas, evitando a sua fermentação antecipada.

Dando meia volta às caixas elas passam a encaixar umas dentro das outras quando vazias, oferecendo uma grande facilidade de manuseamento, e economia de espaço.

Tampa e Base com rodízios disponíveis.

Caixas Fechadas



Ref.	Dim. ext.	Cap.	Quant./paleta
9901_	600x400x150mm	25L	195/ 
9701_	600x400x200mm	35L	190/ 
9751_	600x400x300mm	50L	130/ 

Optando pela **gravação** de 1 lado fica assegurada a fácil distinção entre a posição de empilhamento e a posição de encaixe:

- quando empilhadas, a gravação fica alternada.
- quando encaixadas, as gravações ficam todas do mesmo lado.

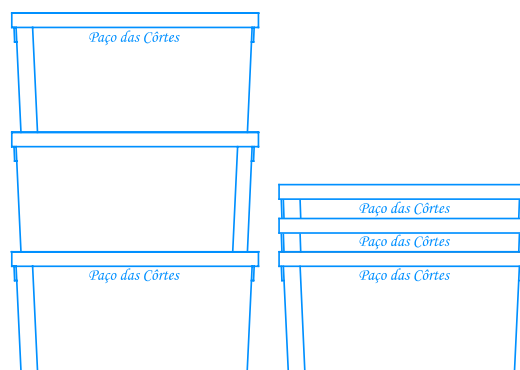

CAIXAS PARA VINDIMA

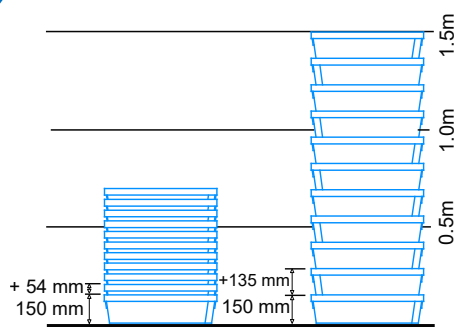

Ref. 990__
(ext.) 600x400x150mm
(int.) 490x332x145mm

25L
+/- 8 kg



Ref. 970__
(ext.) 600x400x200mm
(int.) 490x332x195mm

35L
+/- 12 kg

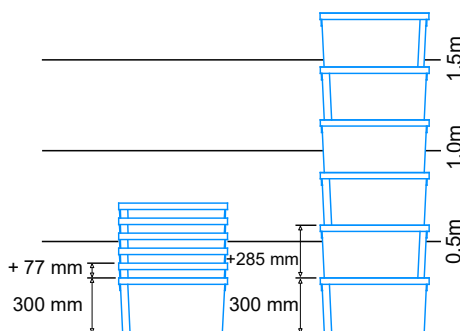
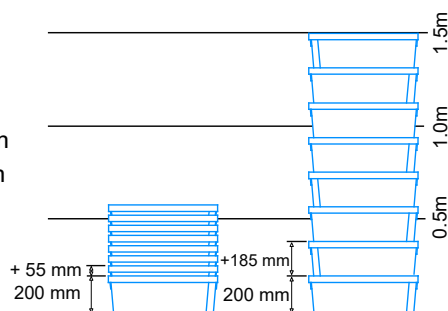

Ref. 975__
(ext.) 600x400x300mm
(int.) 490x332x295mm

50L
+/- 23 kg



Os pesos indicados são valores aproximados
(o valor exato dependerá da forma e do tamanho dos cachos de uvas)

CAIXAS EMPILHÁVEIS E ENCAIXÁVEIS

Série 2000

Caixas Fechadas



2351_

2271_

Empilháveis, e também encaixáveis em vazio para minimizar o volume ocupado, bastando dar meia volta à caixa de cima para encaixar em vez de empilhar na de baixo.

As caixas da Série 2000 asseguram um melhor aproveitamento do espaço interior quando comparadas com outras caixas que também empilham ou encaixam através de uma rotação de 180°.

Ao colocar a **Tampa Ref. 3006_** com cintas de inviolabilidade o conjunto fica completamente fechado, dado que a caixa não tem aberturas junto às pegas.



Ref. 3006_
(600 x 400 mm)



Ref. 9656_
Base com rodízios
(600 x 400 mm)



Ref. 9654_
Base com rodízios
(600 x 400 mm)

Ref.	Dim. ext.	Cap.	Quant./paleta
2271_	600x400x270mm	50L	130/
2351_	600x400x350mm	66L	100/

Caixas Gradeadas

Ref.	Dim. ext.	Cap.	Quant./paleta
2272_	600x400x270mm <i>Por encomenda</i>	50L	130/
2352_	600x400x350mm <i>Por encomenda</i>	66L	100/



2353_

2273_

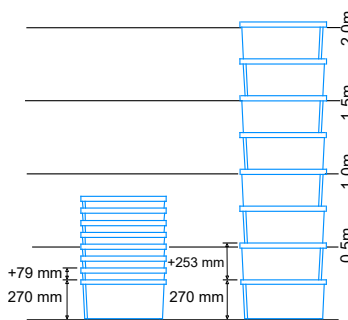

Ref. 227_ _
(ext.) 600x400x270mm
(int.) 490x340x267mm
50L

Ref. 235_ _
(ext.) 600x400x350mm
(int.) 490x340x347mm
66L

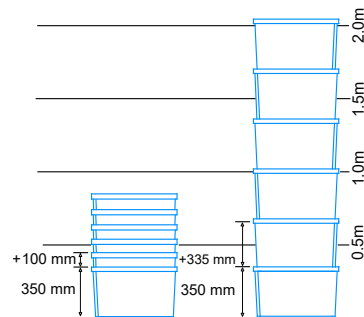

Por encomenda todos os modelos podem ser fabricados:

- com lados gradeados e fundo fechado, ou:
- com lados fechados e fundo gradeado, ou:
- toda gradeada.

Caixas com Fundo fechado e Lados gradeados

Ref.	Dim. ext.	Cap.	Quant./paleta
2273_	600x400x270mm <i>Por encomenda</i>	50L	130/
2353_	600x400x350mm	66L	100/

CAIXAS COM TAMPAS ARTICULADAS

Série 4000 e Série 6000

Caixas Fechadas



Encaixáveis umas na outras para economia de espaço.

Empilháveis sobre as tampas fechadas.

Permitem a colocação de **Clips de inviolabilidade**



Ref. 6402_
(sem numeração)

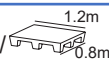
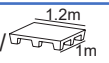
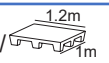
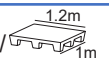
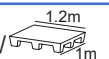

Ref. 6405_
(com numeração sequencial)

Ref.	Dim. ext.	Cap.	Quant./paleta
4326_	400x300x265mm	22L	108/ 
4331_	400x300x310mm	25L	108/ 
6426_	600x400x265mm	48L	72/ 
6431_	600x400x310mm	54L	72/ 
6436_	600x400x365mm	65L	68/ 
6440_	600x400x400mm	70L	68/ 

Janela porta-etiqueta disponível



Ref. 430J_

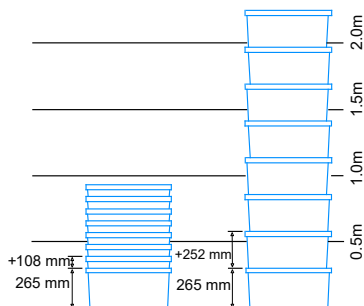

Ref. 4326_
(ext.) 400x300x265mm
(int.) 336x254x239mm
22L



Ref. 640J_

Ref. 4331_
(ext.) 400x300x310mm
(int.) 332x250x282mm
25L

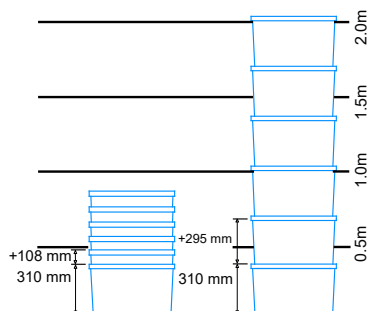

Ref. 9654_
Base com rodízios
(600 x 400 mm)

CAIXAS COM TAMPAS ARTICULADAS

Série 4000 e Série 6000

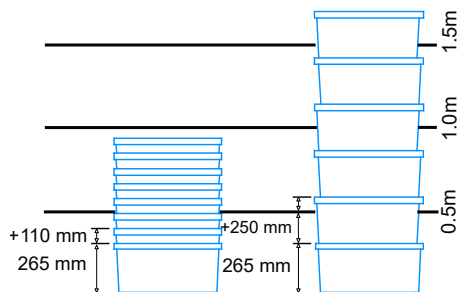

Ref. 6426_

(ext.) 600x400x260mm
(int.) 530x353x240mm

48L



Ref. 6431_

(ext.) 600x400x310mm
(int.) 514x350x281mm

54L

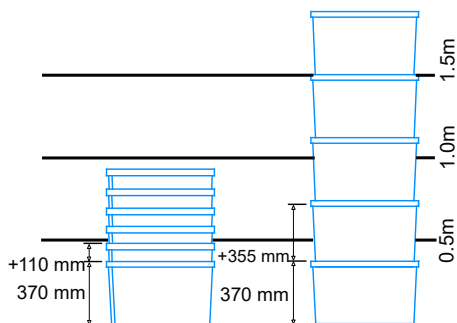
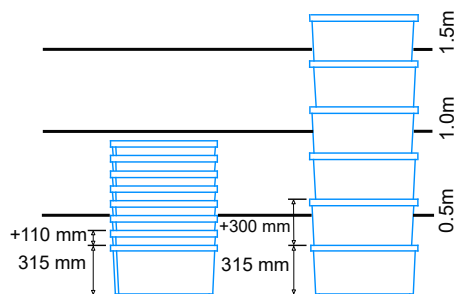

Ref. 6436_

(ext.) 600x400x365mm
(int.) 508x346x340mm

65L



Ref. 6440_

(ext.) 600x400x400mm
(int.) 521x343x375mm

70L

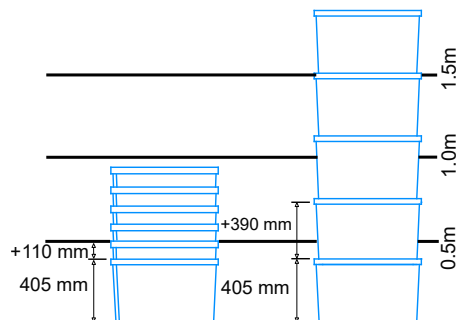

CAIXAS EMPILHÁVEIS E ENCAIXÁVEIS Série 335_

Caixa Fechada



3351_
■

Empilháveis, e também encaixáveis em vazio para minimizar o volume ocupado, bastando dar meia volta à caixa de cima para encaixar em vez de empilhar na de baixo.

Concebidas para possibilitar a movimentação de 4 rimas sobre palete de 1,2 x 1,0m.

Ao colocar a **Tampa Ref. 0210_** o conjunto fica completamente fechado, dado que a caixa não tem aberturas junto às pernas.

Ref.	Dim. ext.	Cap.	Quant./paleta
3351_	620x500x403mm	100L	52/ 



Ref. 0210_
(620 x 500mm)

Caixa com Fundo fechado e Lados gradeados



3353_
■ □



Ref. 9652_
Base com rodízios

Ref.	Dim. ext.	Cap.	Quant./paleta
3353_	620x500x403mm	100L	52/ 



Ref. 335_ _
(ext.) 620x500x403mm
(int.) 521x343x375mm
100L

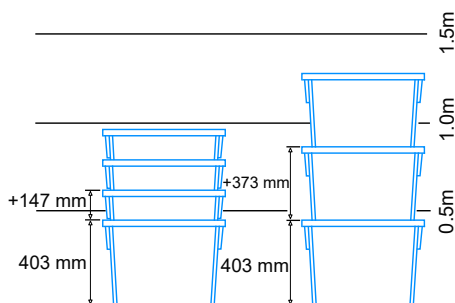

Por encomenda todos os modelos podem ser fabricados:

- toda gradeada, ou:
- com lados fechados e fundo gradeado.

CAIXAS EMPILHÁVEIS



Ref.	Dim. ext.	Cor	Quant./paleta
7870_	680x450x120mm		80/
7871_	680x450x152mm		110/
9015_	435x300x95mm		300/
9280_	500x320x105mm		252/

Caixa empilhável gradeada



332_ _

Caixa empilhável fechada



8470_ _

Ref.	Dim. ext.	Cor	Quant./paleta
332_ _	500x310x255mm		84/
8470_ _	400x300x170mm		130/

Caixa para peixe



9500_ _

Ref.	Dim. ext.	Cor	Quant./paleta
9500_ _	725x485x130mm		54/

Originalmente concebidas para as indústrias de queijo e pastelaria, são também usadas para outras aplicações que requerem dimensões diferentes de 600x400mm ou de 400x300mm.

A **Tampa Ref. 7860_** é adequada para a Ref. 7870_ ou para a Ref. 7871_ e possibilita o empilhamento estável de uma rima de caixas Ref. 9280_ ou 2 rimas de caixas Ref. 9015_.



Ref. 7860_
(680 x 450mm)



Ref. 9654_
Base com rodízios
(600 x 400 / 680 x 450 mm)

Originalmente desenvolvida para o **transporte de peixe**, é também usada para pão de forma e para outras aplicações que requerem dimensões específicas distintas de 600x400mm.

Os furos de drenagem desta caixa estão concebidos de forma a assegurar o escoamento dos líquidos ao longo das paredes exteriores das caixas que estão por baixo, evitando a contaminação por líquidos provenientes das caixas que estão por cima.

Permitem o empilhamento desfasado, de forma a maximizar o espaço nos cascos das embarcações.



CAIXA ENCAIXÁVEL

Caixa usada para controlo de bagagem de mão em aeroportos.



9450_



Ref.	Dim. ext.	Cor	Quant./paleta
9450_	540x380x80mm	<input type="checkbox"/>	750/ 



A grelha também pode ser vendida em separado sob a **Ref. 9452_**.

Caixa com grelhas



9451_



As grelhas **Ref. 9452_** também são compatíveis com as caixas da série 9000.

Ref.	Dim. ext.	Cor	Quant./paleta
9451_	540x380x80mm	<input type="checkbox"/>	750/ 



9901_
e
9452_

CAIXAS COM ARCOS POSICIONÁVEIS Série 1000

Caixas Fechadas



1301_

1201_

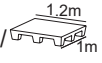
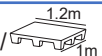
Ref.	Dim. ext.	Cap.	Quant./paleta
1201_	600x400x200mm Por encomenda	35L	140/ 
1301_	600x400x300mm	53L	130/ 

Empilháveis e também encaixáveis em vazio para minimizar o volume ocupado.

O sistema de empilhamento sobre arcos posicionáveis permite maximizar o volume interior.

Tampa e Bases com rodízios disponíveis.



Ref. 3006_
(600 x 400 mm)



Ref. 9654_
Base com rodízios
(600 x 400 mm)





Ref. 9656_
Base com rodízios
(600 x 400 mm)

Caixas Gradeadas

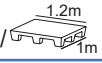

1302_

1202_

Ref.	Dim. ext.	Cap.	Quant./paleta
1202_	600x400x200mm	35L	140/ 
1302_	600x400x300mm	53L	130/ 

Ref. 120_
(ext.) 600x400x200mm
(int.) 530x340x172mm

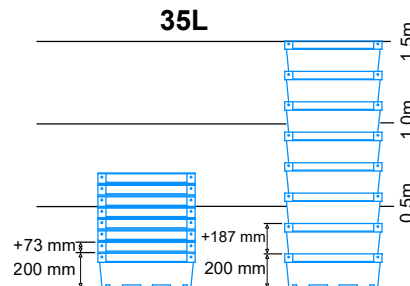

Ref. 130_
(ext.) 600x400x300mm
(int.) 530x340x272mm

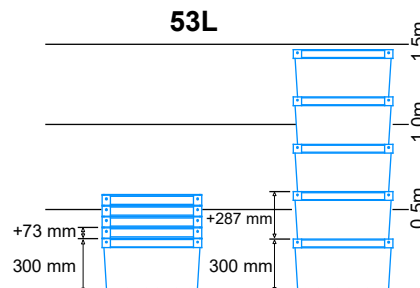

Sob consulta podem fabricar-se com paredes gradeadas e fundo fechado, ou vice-versa

CAIXAS REBATÍVEIS 800x600mm Série 962_



Empilháveis e também rebatíveis em vazio para minimizar o volume ocupado.

A **Tampa Ref. 9635_** permite a colocação de cintas de inviolabilidade.









Ref. 9635_
(800 x 600 mm)

As caixas empilham-se umas sobre as outras, ou sobre as tampas, quer tenham ou não rodízios.

As caixas sem fundo empilham-se sobre outras de forma a duplicar ou triplicar a altura interior.

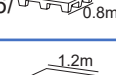
Para acesso lateral existe a versão com portas Ref. 9625_ e também uma versão sem portas, só com abertura lateral Ref. 9628_.

Ref.	Características	Kg	Quant./palete
9620_	Sem fundo	6,72	36/ 
9621_	Com fundo	8,28	36/ 
9622_	Com fundo e rodízios	10,38	20/ 
9625_	Com portas	8,28	36/ 
9626_	Com portas e rodízios	10,38	20/ 
9628_	Com abertura lateral	7,68	36/ 
9629_	Com abertura e rodízios	9,78	20/ 
962P_	Sem fundo, com portas	6,78	36/ 

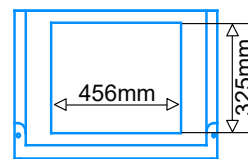

Não inclui as pegas apresentadas nas fotos (cada pega é vendida em separado sob a **Ref. 9636_**).



Ref. 9636_ 

Pegas

Ref. 962_ _

(ext.) 800x600x465mm

(int.) 760x560x450mm

183L

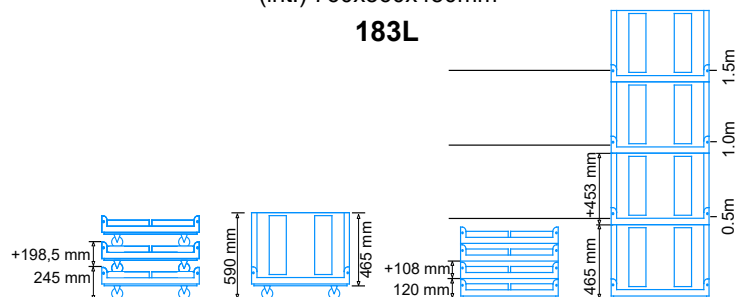

CAIXAS COM ARCOS POSICIONÁVEIS PARA PICKING Série 1000

Caixas com abertura frontal



Ref.	Dim. ext.	Cap.	Quant./paleta
120P_	600x400x200mm <i>Por encomenda</i>	35L	140/ 
1305_	600x400x300mm	53L	130/ 
1306_	600x400x300mm	53L	130/ 
130P_	600x400x300mm	53L	130/ 
130Q_	600x400x300mm	53L	130/ 

Empilháveis e também encaixáveis em vazio para minimizar o volume ocupado.

O sistema de empilhamento sobre arcos posicionáveis permite maximizar o volume interior.



Ref. 3006_
(600 x 400 mm)





Ref. 9654_
Base com rodízios
(600 x 400 mm)



Ref. 9656_
Base com rodízios
(600 x 400 mm)

Caixas com abertura no lado mais comprido



Ref.	Dim. ext.	Cap.	Quant./paleta
130R_	600x400x300mm	53L	130/ 
130T_	600x400x300mm	53L	130/ 

Ref. 1305_ e 1306_
600x400x300mm
53L

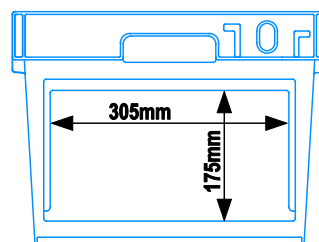

Ref. 130P_ ou Ref. 130Q_
600x400x300mm
53L

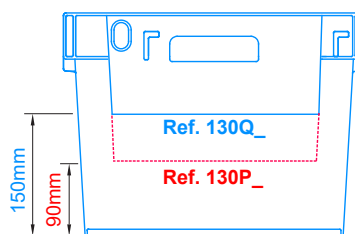

Sob consulta podem fabricar-se com paredes gradeadas e fundo fechado, ou vice-versa

CAIXAS REBATÍVEIS PARA PICKING





Caixas Rebatíveis para Picking 800x600mm

Empilháveis, e também rebatíveis em vazio para minimizar o volume ocupado.



Ref. 9625_

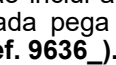

Ref.	Características	Cap.	Quant./paleta
9625_	Com portas	183L	36/ 
9626_	Com portas e rodízios	183L	20/ 
9628_	Com abertura lateral	183L	36/ 
9629_	Com abertura e rodízios	183L	20/ 
9635_	Tampa		80/ 

Não inclui as pegas apresentadas nas fotos (cada pega é vendida em separado sob a Ref. 9636_).



Ref. 9636_
Pegas

Ref. 962_ _
(ext.) 800x600x465mm
(int.) 760x560x450mm
183L

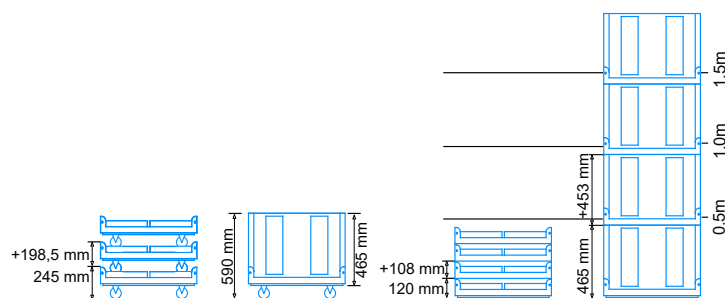

Tampa Ref. 9635_ disponível.



Ref. 9635_
(800 x 600 mm)

CAIXAS PARA A INDÚSTRIA AGRO-ALIMENTAR

Série 961_



Gradeada



Ref.	Dim. ext.	Versão	Quant./paleta
9610_	600x400x59mm Por encomenda	Sem cantos	190/ 
9611_	600x400x77mm Por encomenda	Cantos Baixos	145/ 
9612_	600x400x92mm	Cantos Altos	100/ 

Fechada



Ref.	Dim. ext.	Versão	Quant./paleta
9613_	600x400x59mm Por encomenda	Sem cantos	190/ 
9614_	600x400x77mm Por encomenda	Cantos Baixos	145/ 
9615_	600x400x92mm	Cantos Altos	100/ 

Fundo Fechado, Lados Gradeados



Ref.	Dim. ext.	Versão	Quant./paleta
9616_	600x400x59mm	Sem cantos	190/ 
9617_	600x400x77mm	Cantos Baixos	145/ 
9618_	600x400x92mm Por encomenda	Cantos Altos	100/ 

Empilháveis.

Adequadas para o transporte e armazenagem dos mais diversos produtos (pão, bolos, queijos, carnes, hambúrgueres, massas, frutos, legumes, etc.).

Tampa e Base com rodízios disponíveis.



Ref. 3006_
(600 x 400 mm)

Ref. 9654_
Base com rodízios
(600 x 400 mm)

Por encomenda podemos fabricar mais 3 versões:

- fundo gradeado, lados fechados sem cantos
- fundo gradeado, lados fechados cantos baixos
- fundo gradeado, lados fechados cantos altos

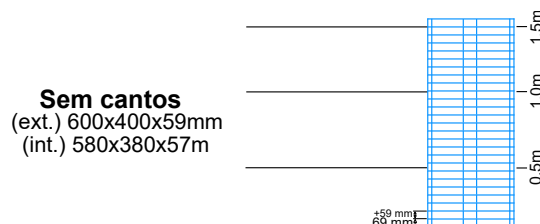
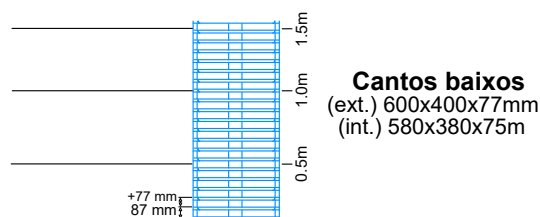
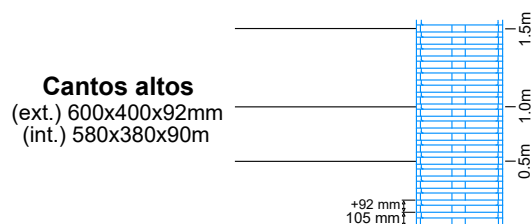

Sob consulta: Personalização com o nome da sua empresa, site, telefone, ou logótipo.

PALETES E ESTRADOS

Paletes



2281_
□



9662_
□

Ref.	Dim. ext.	KG	Quant./paleta
2281_	1200x800x150mm	6,9	50/
9662_	1200x800x145mm	14,4	16/

Paletes e estrados adequados para contato alimentar.

A paleta **Ref. 2281_** não é adequada para uso em estanteria.

Estas paletes com 9 pés (sem travessas) encaixam umas nas outras. Quando encaixadas, a primeira ocupa uma altura de apenas 150mm e cada uma das seguintes ocupa mais 45mm.

Ref. 2281_ Carga (Kg)	
Estática	Dinâmica
1000	800

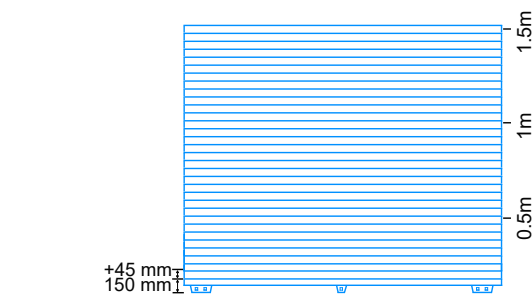

Estrados



9660_
■



9661_
■

Ref.	Dim. ext.	KG	Quant./paleta
9660_	500x500x48mm	1,8	160/
9661_	500x500x24mm	0,82	560/

Ref. 9662_ Carga (Kg)		
Estática	Dinâmica	Esteria
1000	800	400

As paletes **Ref. 9662_** têm 2 travessas e são adequadas para uso em estanteria.

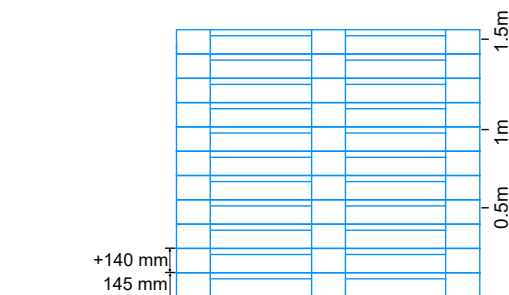

BALDES INVIOLÁVEIS E BALDE RETANGULAR

Baldes com patilha de inviolabilidade



Branco, ou fundo transparente com tampa branca



Branco

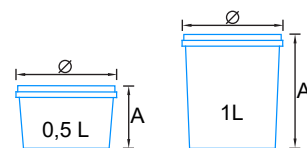



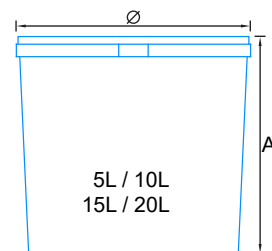



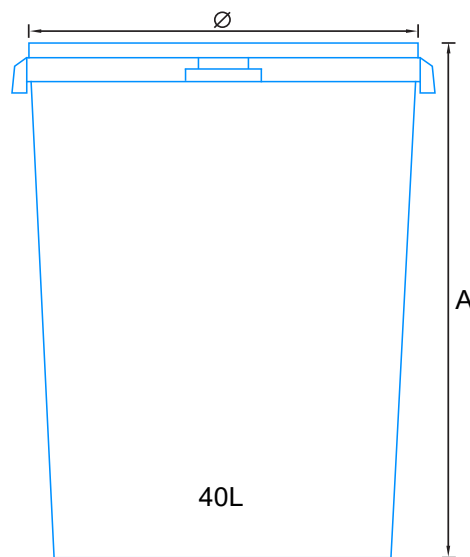

SEM ASA



COM ASA



COM PEGAS

Ref.	Dim. ext.	Cap. L		Quant./paleta
		Nominal	Total	
9083_	Ø120xA78mm	0,5	0,6	5500/  1.2m / 0.8m
9093_	Ø120xA135mm	1	1,1	3300/  1.2m / 0.8m
911_ _	Ø202xA218mm	5	5,2	800/  1.2m / 400/  0.8m
9123_	Ø275xA247mm	10	10,3	480/  1.2m / 240/  1m
9713_	Ø309xA275mm	15	15,5	396/  1.2m / 1m
9133_	Ø340xA335mm	20	23	288/  1.2m / 1m
9222_	Ø380xA510mm	40	44	180/  1.2m / 0.8m

Balde retangular

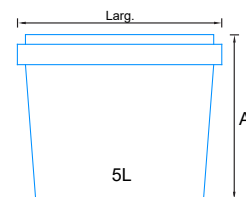
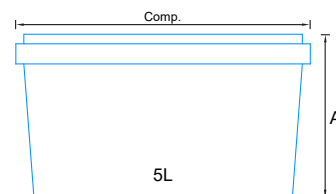

COM ASA

Ref.	Dim. ext.	Cap. L		Quant./paleta
		Nominal	Total	
9561_	290x198x152mm	5	5,9	500/  1.3m / 1000/  1.1m

Frascos com Tampa de Bico

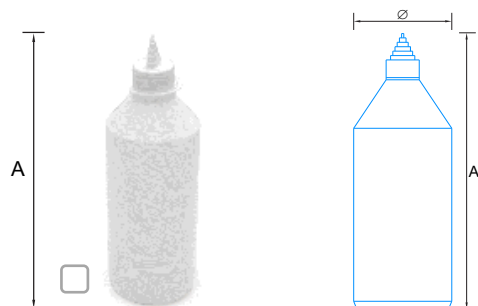

Ref.	Dim. ext.	Cap.	Quant./paleta
9021_	Ø55x \underline{A} 78mm Por encomenda	250cm ³	3456/ 
9141_	Ø70x \underline{A} 215mm	500cm ³	2160/ 
9231_	Ø89x \underline{A} 250mm Por encomenda	1000cm ³	1152/ 

As tampas de bico vêm com o bico selado. Ao usar o frasco pela primeira vez, é preciso cortar o bico para abrir um orifício. Após a primeira utilização, é possível fechar o orifício utilizando a tampinha acoplada à própria tampa.

Frascos com tampa de rosca inviolável



9143_

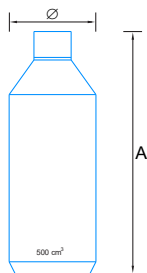



Frasco inviolável com tampa de segurança para crianças

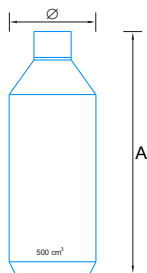

9144_



Ref.	Dim. ext.	Cap.	Quant./paleta
9143_	Ø70x \underline{A} 195m	500cm ³	2160/ 
9144_	Ø70x \underline{A} 198mm	500cm ³	2160/ 

Para todos os frascos e pistola pulverizadora **recomenda-se a realização de ensaios** para verificar a resistência química ao produto embalado.

Frasco com Pistola Pulverizadora

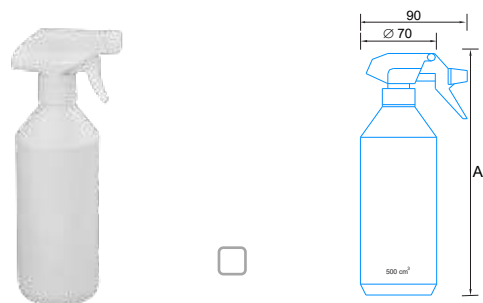

Ref.	Dim. ext.	Cap.	Quant./paleta
9142_	Ø70x \underline{A} 233m	500cm ³	2160/ 





BOIÕES COM TAMPA INVIOLÁVEL COLOCÁVEL À PRESSÃO

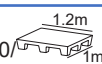
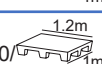
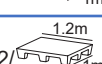

Boiões e Tampas adequados para contato com alimentos conforme a regulamentação Europeia.

As tampas apresentam uma cinta de inviolabilidade, que é necessário remover para permitir a abertura.

Ref.	Dim. ext.	Cap.	Quant./paleta
9470_	Ø68x \underline{A} 66mm	125cm ³	2400/ 
9390_	Ø68x \underline{A} 194mm	250cm ³	2160/ 
9370_	Ø100x \underline{A} 98mm	500cm ³	1440/ 
9371_	Ø100x \underline{A} 118mm Por encomenda	650cm ³	1440/ 
9372_	Ø100x \underline{A} 132mm Por encomenda	750cm ³	1440/ 
9380_	Ø100x \underline{A} 161mm	1000cm ³	1152/ 
9381_	Ø100x \underline{A} 181mm Por encomenda	1150cm ³	1152/ 
9382_	Ø100x \underline{A} 195mm Por encomenda	1250cm ³	1152/ 
9271_	Ø100x \underline{A} 242mm	2000cm ³	1152/ 



Os boiões são fabricados em Polietileno de Alta Densidade em branco.
As tampas são fabricadas em Polietileno de Baixa Densidade.

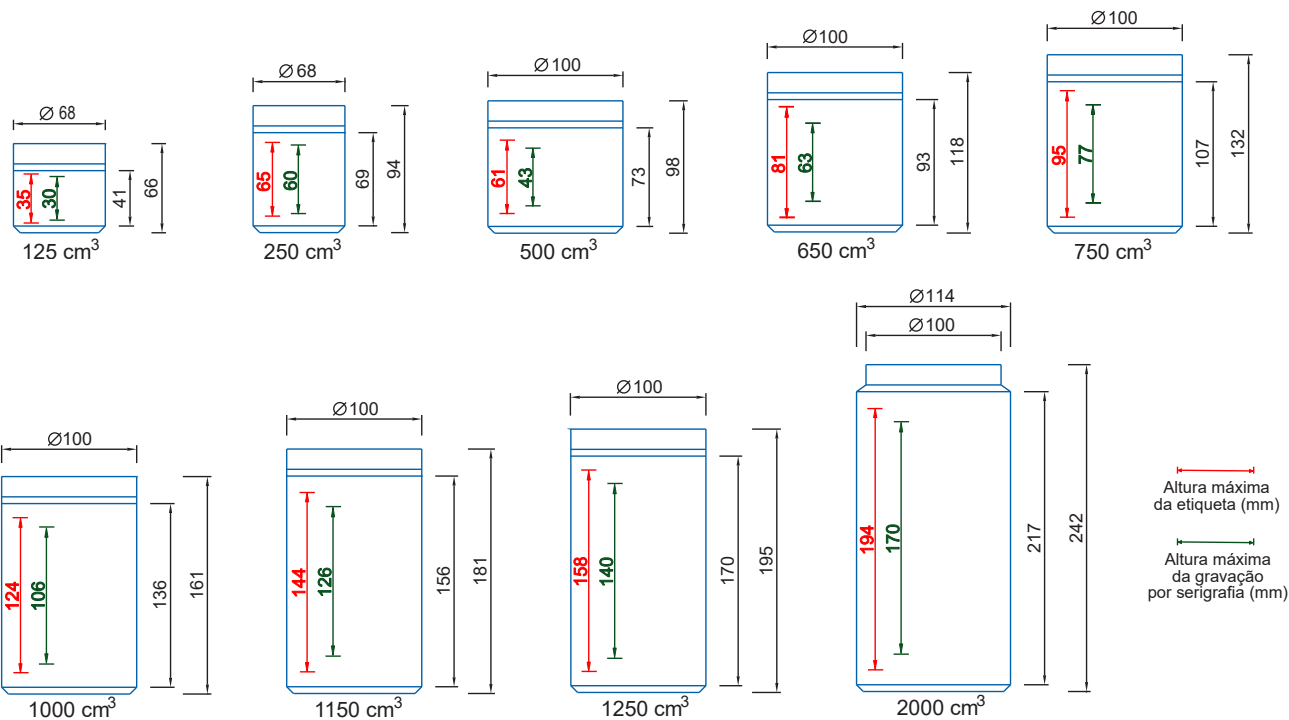

RECIPIENTES PARA RECOLHA SELETIVA

Contentores de 60L







Para recolha seletiva de resíduos

Contentor com pedal **Ref. 9580_** disponível em:

- Branco, ou:
- Cinza com tampa Azul, Amarela, Verde, ou Cinza-Claro



Ref.	Dim. ext.	Cap.	Quant./paleta
7880_	680x450x120mm	60L	110/  1.3m/1.1m
9570_	585x435x360mm	60L	80/  1.3m/1.1m
9580_	730x430x400mm	60L	18/  1.3m/1.1m
9590_	680x435x345mm	60L	57/  1.3m/1.1m

Papeleira com tampa basculante **Ref. 9590_** disponível em:

- Cinza com tampa Azul, Amarela, Verde, ou Cinza-Claro

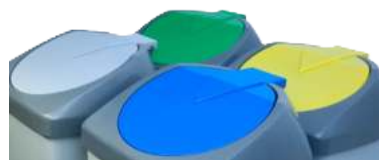



Papeleiras com tampa vai-vém



Opção de personalização do vai-vém e fundo da **Ref. 9224_** com gravação por serigrafia, até 4 cores.



Ref.	Dim. ext.	Cap.	Quant./paleta
8901_	390x200x200mm	8L	360/  1.2m/1m
9224_	90x420(Ø380)mm	40L	126/  1.2m/0.8m

RECIPIENTES PARA RECOLHA SELETIVA/ BALDÃO PARA RESÍDUOS



Papeleiras

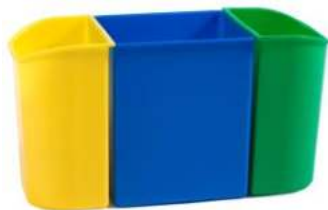

8900_
□



0230_ 0240_
■ ■ ■ ■

Ref.	Dim. ext.	Cap.	Quant./paleta
8900_	295x195x195mm	8L	780/ 
0230_	217x160x290mm	6,2L	560/ 
0240_	217x255x290mm	13,5L	380/ 

Baldão sem tampa **Ref. 7900_**.

Baldão com tampa **Ref. 7901_**.

Tampa **Ref. 7902_** disponível



Ref. 7902_
■



Baldão para resíduos Capacidade 80L



■ **7900_**



■ **7901_**

Ref.	Dim. ext.	Cap.	Quant./paleta
7900_	Ø480X670mm	80L	44/ 
7901_	Ø480X670mm	80L	40/ 

Exemplos de utilização

Limpeza Urbana



O carro não é vendido pela PSAplast

CABIDES COM GANCHO

NORMAL OU ANTI-ROUBO



■ 8910_

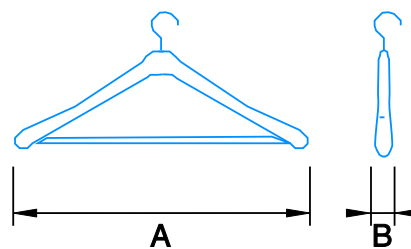

Argola metálica para cabides com espigão anti-roubo.



■ 8911_



8913_

Argola plástica para cabides com espigão anti-roubo.
Aplicável sem desmontar o varão.

Ref.	Dim. ext.	Características
8910_	A420xB30mm	Com gancho
8911_	A420xB30mm	Com espigão anti-roubo



■ 8914_

Placas com gravação do logótipo nos cabides Ref. 8910_ ou 8911_.



Bandejas



■ 8332_

■ 8882_

■ 2092_

Ref.	Dim. ext.	Características
2092_	410x330mm	Com superfície rugosa
8882_	530x325mm Por encomenda	Com superfície lisa
8332_	480x370mm	Com superfície rugosa



□ 7992_



□ 8201_

Ref.	Dim. ext.	Designação
7992_	590x400mm	Tabuleiro TV
8201_	480x295mm	Mesa de ir à cama

Mala de Primeiros Socorros



□ 8810_

Com opção
de gravação

Ref.	Dim. ext.	Características
8810_	240x190x45mm Por encomenda	Modelo vazio

Bandejas Self-Service em Poliestireno resistente ao choque.

Ideais para Hospitais, Lares, Cantinas, etc.

Colher, copos, caixas de 1L e 2L e jarro graduado de 1L



Ref.	Designação	Cap.
4440_	Caixa Ø480X670mm	26 ml
8691_	Caixa 185x125x70mm	1L
8701_	Caixa 235x150x95mm	2L
9530_	Jarro graduado	1L

Por encomenda

Ref.	Designação	Cap.
0180_	Colher doseadora	15cm ³
211_	Copo 49x50mm	60cm ³
250_	Copo 46x37mm	37,5cm ³
252_	Copo 59x55mm	87,5cm ³
351_	Copo 72x85mm	240cm ³
352_	Copo 92x105mm	480cm ³
416_	Copo 59x80mm	137,5cm ³
771_	Taça 72x43mm	100cm ³

CENTRO 2030

Os Fundos Europeus mais próximos de si.



**Cofinanciado pela
União Europeia**