

# 180° TURN STACK & NESTING BOXES 9000 series

## Solid Boxes



When empty they nest in each other to reduce the volume. Stacks by turning 180°.

The apertures below the handles facilitate the handling of the box.

The **Lid Ref. 3006\_** enables the use of security straps, for tamper evidence.

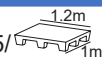
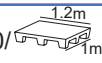
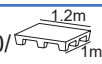
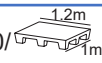

**Ref. 3006\_**  
(600 x 400 mm)

Ref.	Ext. dim.	Cap.	Qty./pallet
<b>9901_</b>	600x400x150mm	25L	195/ 
<b>9701_</b>	600x400x200mm	35L	190/ 
<b>9751_</b>	600x400x300mm	50L	130/ 
<b>9801_</b>	600x400x400mm	70L	90/ 



**Ref. 9654\_**  
Dolly  
(600 x 400 mm)

## Perforated Boxes

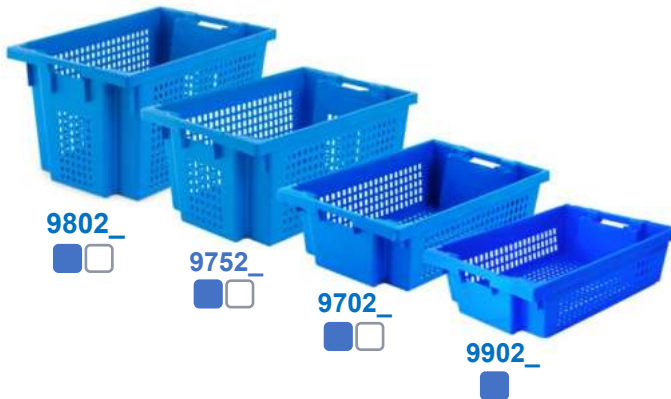

**Ref. 9656\_**  
Dolly  
(600 x 400 mm)

Ref.	Ext. dim.	Cap.	Qty./pallet
<b>9902_</b>	600x400x150mm <b>On request</b>	25L	195/ 
<b>9702_</b>	600x400x200mm	35L	190/ 
<b>9752_</b>	600x400x300mm	50L	130/ 
<b>9802_</b>	600x400x400mm	70L	90/ 

On request, all models may be produced:

- with perforated walls and solid base, or;
- with solid walls and perforated base, or;
- with wheels, perforated walls and base (Ref. 990R, 970R, and 980R);
- with wheels, solid walls and perforated base.



**980R\_**

# 180° TURN STACK & NESTING BOXES 9000 series

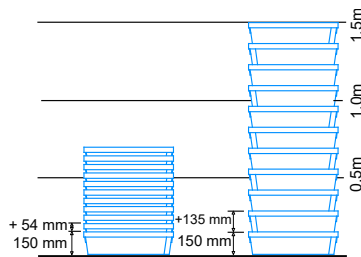

**Ref. 990\_\_**  
(ext.) 600x400x150mm  
(int.) 490x332x145mm

**25L**



**Ref. 970\_\_**  
(ext.) 600x400x200mm  
(int.) 490x332x195mm

**35L**

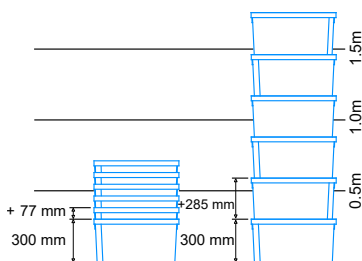
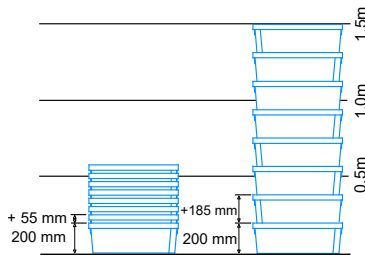

**Ref. 975\_\_**  
(ext.) 600x400x300mm  
(int.) 490x332x295mm

**50L**



**Ref. 980\_\_**  
(ext.) 600x400x400mm  
(int.) 490x332x395mm

**70L**

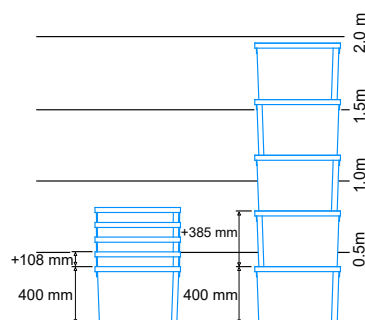

On request, all models may be produced:

- with perforated walls and solid base, or:
- with solid walls and perforated base, or:
- with wheels, perforated walls and base (Ref. 990R, 970R, and 980R):
- with wheels, solid walls and perforated base.

# GRAPE HARVEST





The boxes are stackable. You may stack multiple boxes without crushing the grapes, preventing premature fermentation.

By turning the boxes 180°, they nest inside each other when empty, for ease of handling and space saving.

**Lid and dolly** available.

## Solid Boxes



Ref.	Ext. dim.	Cap.	Qty./pallet
9901_	600x400x150mm	25L	195/ 
9701_	600x400x200mm	35L	190/ 
9751_	600x400x300mm	50L	130/ 

**Printing** on one side enables the user to distinguish between the stacking and the nesting positions:

- when stacked, the prints alternate.
- when nested, all the prints are on the same side

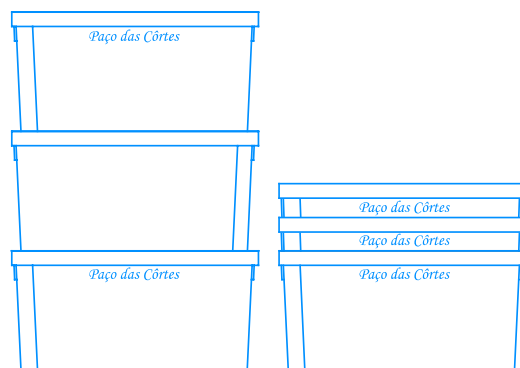

# GRAPE HARVEST

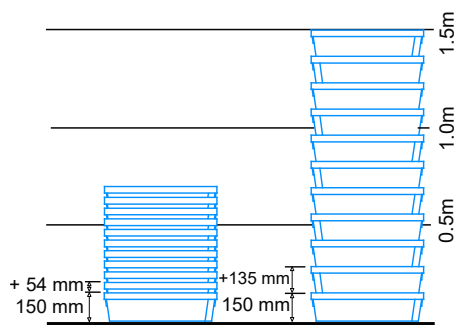

**Ref. 990\_\_**  
(ext.) 600x400x150mm  
(int.) 490x332x145mm

**25L**  
+/- 8 kg



**Ref. 970\_\_**  
(ext.) 600x400x200mm  
(int.) 490x332x195mm

**35L**  
+/- 12 kg

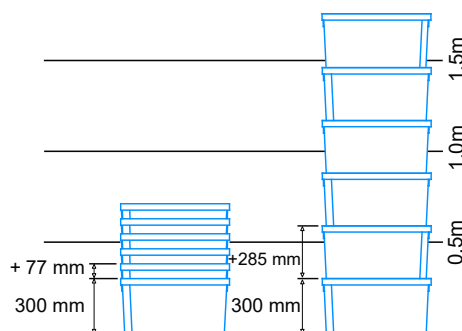
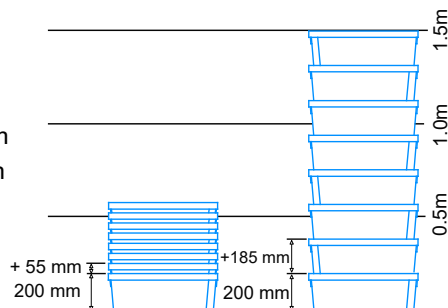

**Ref. 975\_\_**  
(ext.) 600x400x300mm  
(int.) 490x332x295mm

**50L**  
+/- 23 kg



The weights of grapes are a rough indication.

# 180° TURN STACK & NESTING BOXES 2000 series

## Solid Boxes



2351\_

2271\_

When empty they nest in each other to reduce the volume. Stacks by turning 180°.

These 2000 Series boxes offer an increased internal volume when compared with other 180° turn stack & nesting boxes.

When fitting a **Lid Ref. 3006\_** with security straps, tamper evidence is ensured because these boxes do not have apertures below the handles.

Ref.	Ext. dim.	Cap.	Qty./pallet
2271_	600x400x270mm	50L	130/
2351_	600x400x350mm	66L	100/



Ref. 3006\_   
(600 x 400 mm)

Ref. 9656\_  
Dolly  
(600 x 400 mm)

Ref. 9654\_  
Dolly  
(600 x 400 mm)

## Perforated Boxes

Ref.	Ext. dim.	Cap.	Qty./pallet
2272_	600x400x270mm <i>On request</i>	50L	130/
2352_	600x400x350mm <i>On request</i>	66L	100/



2353\_

2273\_

## Boxes with solid base and perforated walls

Ref.	Ext. dim.	Cap.	Qty./pallet
2273_	600x400x270mm <i>On request</i>	50L	130/
2353_	600x400x350mm	66L	100/

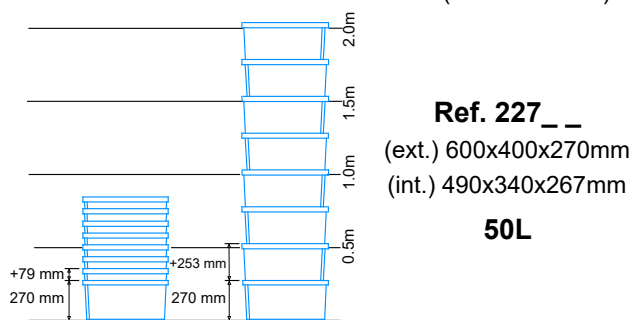

Ref. 227\_ \_  
(ext.) 600x400x270mm  
(int.) 490x340x267mm  
**50L**

Ref. 235\_ \_  
(ext.) 600x400x350mm  
(int.) 490x340x347mm  
**66L**

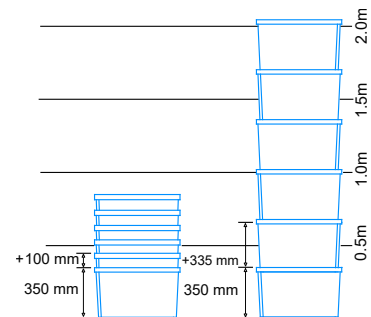

On request all models may be produced:

- with solid base and perforated walls, or:
- with solid walls and perforated base, or:
- perforated.

# ATTACHED LID BOXES 4000 series and 6000 series

## Solid Boxes



Nest when empty.

Stack on the closed lids.

Enable the use of **security seals**, for tamper evidence.



Ref. 6402\_  
(without numbering)

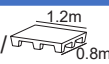
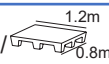
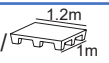
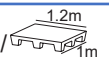
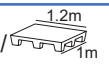
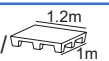

Ref. 6405\_  
(with sequential numbering)

Ref.	Ext. dim.	Cap.	Qty./pallet
4326_	400x300x265mm	22L	108/ 
4331_	400x300x310mm	25L	108/ 
6426_	600x400x265mm	48L	72/ 
6431_	600x400x310mm	54L	72/ 
6436_	600x400x365mm	65L	68/ 
6440_	600x400x400mm	70L	68/ 

Optional **ticket-window** available



Ref. 430J\_

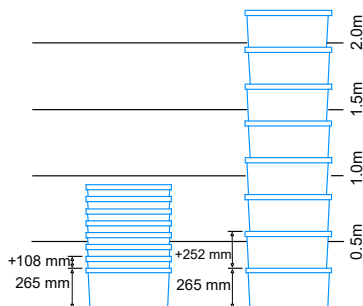

Ref. 4326\_  
(ext.) 400x300x265mm  
(int.) 336x254x239mm  
**22L**



Ref. 640J\_

Ref. 4331\_  
(ext.) 400x300x310mm  
(int.) 332x250x282mm  
**25L**

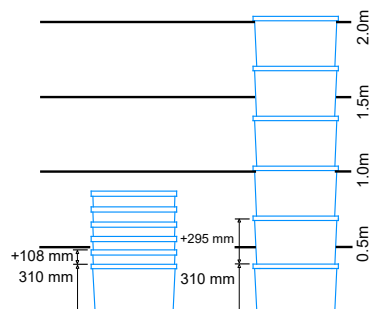

Ref. 9654\_  
Dolly  
(600 x 400 mm)

# ATTACHED LID BOXES 4000 series and 6000 series

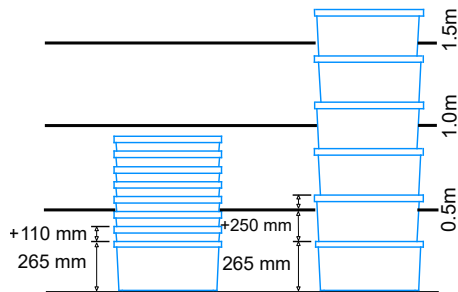

**Ref. 6426\_**  
(ext.) 600x400x260mm  
(int.) 530x353x240mm  
**48L**



**Ref. 6431\_**  
(ext.) 600x400x310mm  
(int.) 514x350x281mm  
**54L**

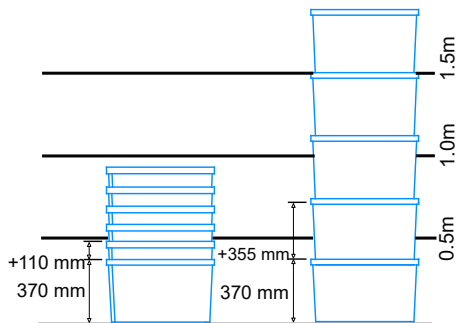
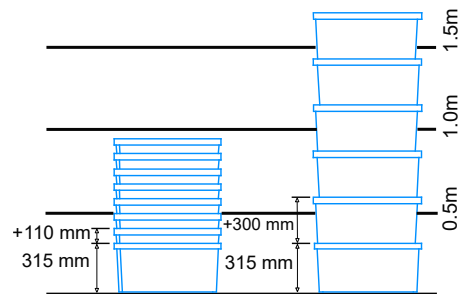

**Ref. 6436\_**  
(ext.) 600x400x365mm  
(int.) 508x346x340mm  
**65L**



**Ref. 6440\_**  
(ext.) 600x400x400mm  
(int.) 521x343x375mm  
**70L**

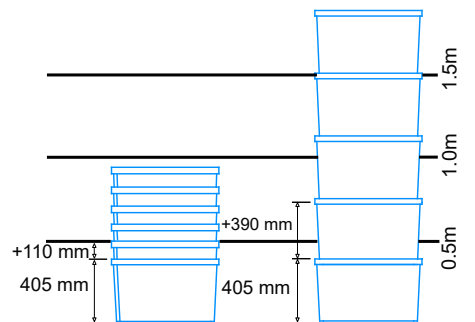

# 180° TURN STACK & NESTING BOXES 620x500mm 335\_ series (100L)

## Solid Box



3351\_  
■

Ref.	Ext. dim.	Cap.	Qty./pallet
3351_	620x500x403mm	100L	52/ 

When empty they nest in each other to reduce the volume. Stacks by turning 180°.

Designed to enable loading of 4 piles on 1,2x1,0m pallets.

When fitting a **Lid Ref. 0210\_**, tamper evidence is ensured because these boxes do not have apertures below the handles.



Ref. 0210\_  
(620 x 500mm)

## Box with solid base and perforated walls



3353\_  
■ □

Ref.	Ext. dim.	Cap.	Qty./pallet
3353_	620x500x403mm	100L	52/ 



Ref. 9652\_  
Dolly

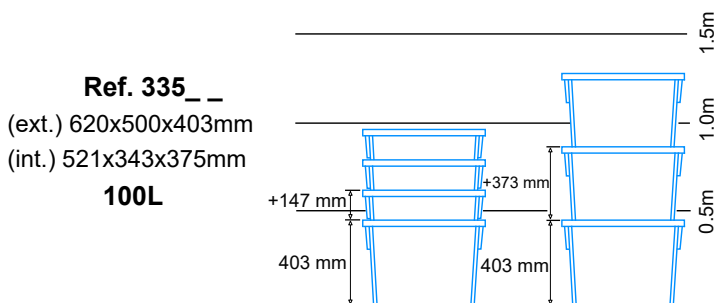

On request all models may be produced:

- perforated, or:
- with solid walls and perforated base.



# STACKING BOXES



Originally developed for the cheese and pastry industries, they are also used for other applications requiring dimensions different from 600x400mm or 400x300mm.

The **Lid Ref. 7860\_** is suitable for Ref. 7870\_ and Ref. 7871\_, and it enables stable stacking of one pile of Ref. 9280\_ or 2 piles of Ref. 9015\_.

Ref.	Ext. dim	Colour	Qty./pallet
7870_	680x450x120mm		80/
7871_	680x450x152mm		110/
9015_	435x300x95mm		300/
9280_	500x320x105mm		252/



**Ref. 7860\_**  
(680 x 450mm)

## Perforated Box



**332\_ \_**

## Solid Box



**8470\_**



**Ref. 9654\_**  
Dolly  
(600 x 400 / 680 x 450 mm)

Ref.	Ext. dim.	Colour	Qty./pallet
332_ _	500x310x255mm		84/
8470_	400x300x170mm		130/

Originally developed as a **fish box**, it is also used for many other applications which require specific dimensions different from 600x400mm.

The drainage holes in the box are designed to ensure that liquids drain along the outer walls of the boxes below, preventing contamination by liquids from the boxes above.

Its design enables staggered stacking in order to optimise the use of space in the hulls of fishing boats.

## Fish Box



**9500\_**

Ref.	Ext. dim.	Colour	Qty./pallet
9500_	725x485x130mm		54/



# STACKING BOXES



9450\_

Tray used for hand luggage inspection at airports.

The counter display tray is available with or without grids.



Ref.	Ext. dim.	Colour	Qty./pallet
9450_	540x380x80mm	<input type="checkbox"/>	750/ 



The grid may also be sold separately under Ref. 9452\_.

## Tray with grids



9451\_



The grids Ref. 9452\_ are also compatible with the 9000 series boxes.

Ref.	Ext. dim.	Colour	Qty./pallet
9451_	540x380x80mm	<input type="checkbox"/>	750/ 



9901\_   
and 9452\_



# BALE-ARM STACK & NESTING BOXES 1000 series

## Solid Boxes



1301\_  
■

1201\_  
■

Ref.	Ext. dim.	Cap.	Qty./pallet
1201_	600x400x200mm <b>On request</b>	35L	140/ 
1301_	600x400x300mm	53L	130/ 

Stack, and also nest when empty to minimize the volume.

The bale-arm stacking design maximizes the internal volume. Includes label holders on the 2 short ends.

**Lid and dollies** available.



Ref. 3006\_  
(600 x 400 mm)



Ref. 9654\_  
Dolly  
(600 x 400 mm)



Ref. 9656\_  
Dolly  
(600 x 400 mm)

## Perforated Boxes



1302\_  
■

1202\_  
■

Ref.	Ext. dim.	Cap.	Qty./pallet
1202_	600x400x200mm	35L	140/ 
1302_	600x400x300mm	53L	130/ 

Ref. 120\_  
(ext.) 600x400x200mm  
(int.) 530x340x172mm

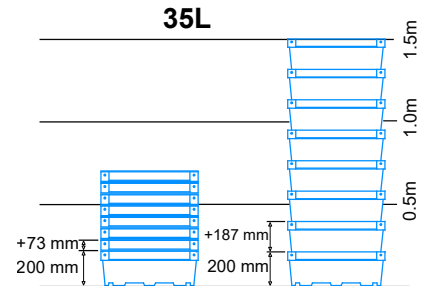

Ref. 130\_  
(ext.) 600x400x300mm  
(int.) 530x340x272mm

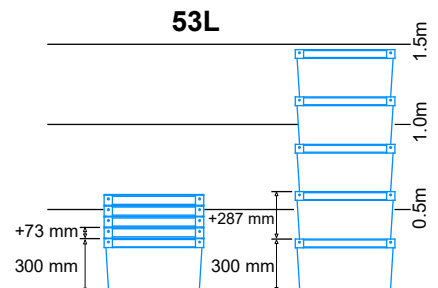

All models may be produced with perforated walls and solid base, or vice-versa.

# 800x600mm FOLDING BOXES 962\_ series



Stackable and foldable when empty to minimize the volume.

The Lid Ref. 9635\_ enables the use of security seals, for tamper evidence.







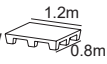

**Ref. 9635\_**  
(800 x 600 mm)

The boxes may be stacked on each other or over the lids, with or without castor wheels.

The box with drop-doors Ref. 9625\_ enables side access. The box is also available with side aperture (without doors) Ref. 9628\_.

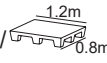
Boxes with open base may be stacked on other boxes to increase the internal height.

Ref.	Features	Kg	Qty./pallet
9620_	Open base	6,72	36/ 
9621_	Solid base	8,28	36/ 
9622_	Solid base and castor wheels	10,38	20/ 
9625_	Drop doors	8,28	36/ 
9626_	Drop doors & wheels	10,38	20/ 
9628_	With side aperture	7,68	36/ 
9629_	With side aperture & wheels	9,78	20/ 
962P_	With doors & open base	6,78	36/ 

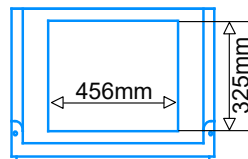

Does not include the handles shown in the pictures (each handle is sold separately under Ref. 9636\_).



**Ref. 9636\_** 

Handles

## Ref. 962\_ \_

(ext.) 800x600x465mm  
(int.) 760x560x450mm

**183L**

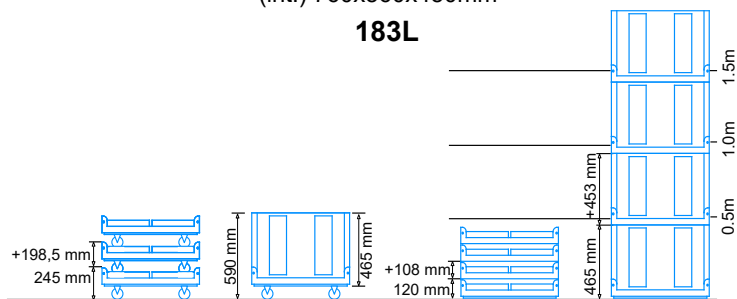

# BALE-ARM PICKING BOXES

## 1000 series

### Boxes with aperture on the short side



Ref.	Ext. dim.	Cap.	Qty./pallet
120P_	600x400x200mm <i>On request</i>	35L	140/
1305_	600x400x300mm	53L	130/
1306_	600x400x300mm	53L	130/
130P_	600x400x300mm	53L	130/
130Q_	600x400x300mm	53L	130/

Stack, and also nest when empty to minimize the volume.

The bale-arm stacking design maximizes the internal volume. Includes label holders on the 2 short ends.



Ref. 3006\_  
(600 x 400 mm)



Ref. 9654\_  
Dolly  
(600 x 400 mm)



Ref. 9656\_  
Dolly  
(600 x 400 mm)

### Boxes with aperture on one long wall



Ref.	Ext. dim.	Cap.	Qty./pallet
130R_	600x400x300mm	53L	130/
130T_	600x400x300mm	53L	130/

Ref. 1305\_ e 1306\_  
600x400x300mm  
53L

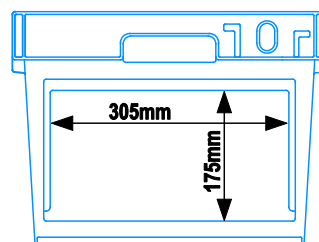

Ref. 130P\_ ou Ref. 130Q\_  
600x400x300mm  
53L

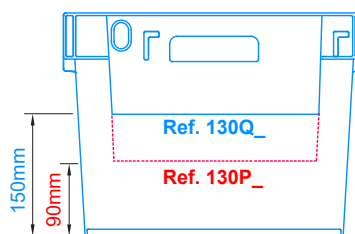

All models may be produced with perforated walls and solid base, or vice-versa.

# FOLDING PICKING BOXES



## 800x600mm Folding Picking Boxes

Stack, and also nest when empty to minimize the volume.



Ref. 9625\_  
■

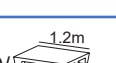
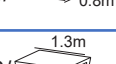

Ref.	Features	Cap.	Qty./pallet
9625_	Drop doors	183L	36/ 
9626_	Drop doors & wheels	183L	20/ 
9628_	With side aperture	183L	36/ 
9629_	With side aperture & wheels	183L	20/ 
9635_	Lid		80/ 

Does not include the handles shown in the pictures (each handle is sold separately under Ref. 9636\_).



Ref. 9636\_  
■  
Handles

Ref. 962\_ \_  
(ext.) 800x600x465mm  
(int.) 760x560x450mm  
**183L**

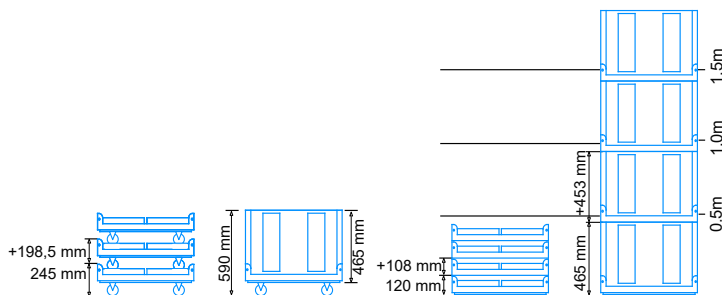

Lid Ref. 9635\_ is available



Ref. 9635\_  
(800 x 600 mm)

# TRAYS FOR THE AGRICULTURE AND FOOD INDUSTRIES 961\_ series



## Perforated



9610\_

9611\_

9612\_

Ref.	Ext. dim.	Version	Qty./pallet
9610_	600x400x59mm <b>On request</b>	<b>Without Corners</b>	190/ 
9611_	600x400x77mm <b>On request</b>	<b>With low Corners</b>	145/ 
9612_	600x400x92mm	<b>With high Corners</b>	100/ 



## Solid



9613\_

9614\_

9615\_

Ref.	Ext. dim.	Version	Qty./pallet
9613_	600x400x59mm <b>On request</b>	<b>Without Corners</b>	190/ 
9614_	600x400x77mm <b>On request</b>	<b>With low Corners</b>	145/ 
9615_	600x400x92mm	<b>With high Corners</b>	100/ 



## Solid Base, Perforated Walls



9616\_

9617\_

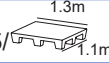
9618\_

Ref.	Ext. dim.	Version	Qty./pallet
9616_	600x400x59mm	<b>Without Corners</b>	190/ 
9617_	600x400x77mm	<b>With low Corners</b>	145/ 
9618_	600x400x92mm <b>On request</b>	<b>With high Corners</b>	100/ 

Stacking trays suitable for transport and storage of a wide range of products (bread, pastry, cheese, meat, hamburgers, pasta, fruit, vegetables, etc.).

Lid and dolly available.



Ref. 3006\_ (600 x 400 mm)



Ref. 9654\_ Dolly (600 x 400 mm)

On request another 3 models not presented by the photos may be produced:

- with solid walls, perforated base without corners, or:
- with solid walls, perforated base with low corners, or:
- with solid walls, perforated base with high corners.

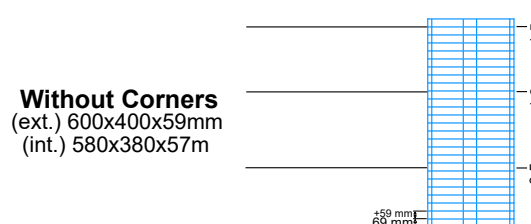
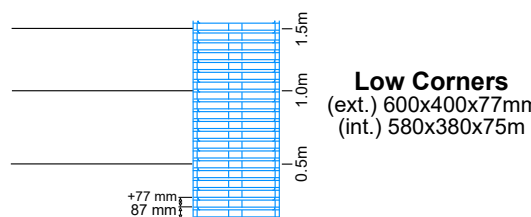
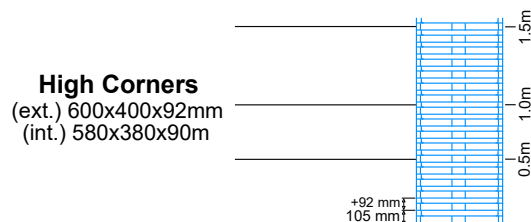

On request: Marking with your company's name, address or logo.

## Pallets



2281\_

Ref. 2281_ Load (Kg)	
Static	Dynamic
1000	800

Ref.	Ext. dim.	KG	Qty./pallet
2281_	1200x800x150mm	6,9	50/ 

This pallet is suitable for food contact.

Pallet **Ref. 2281\_** is not suitable for racking. With 9 feet (no skids). Nests to save space.

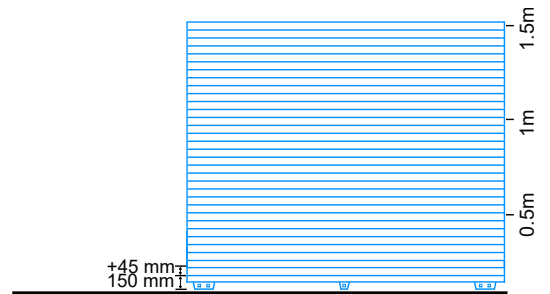



# TAMPER EVIDENT BUCKETS & OBLONG BUCKET

## Tamper Evident Buckets



White, or transparent base with white lid



White

Suitable for food contact. Comply with the European food contact regulations.

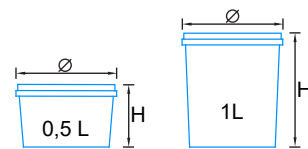



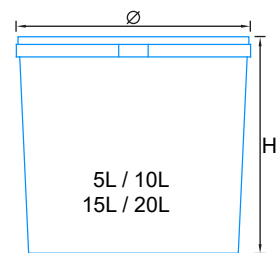



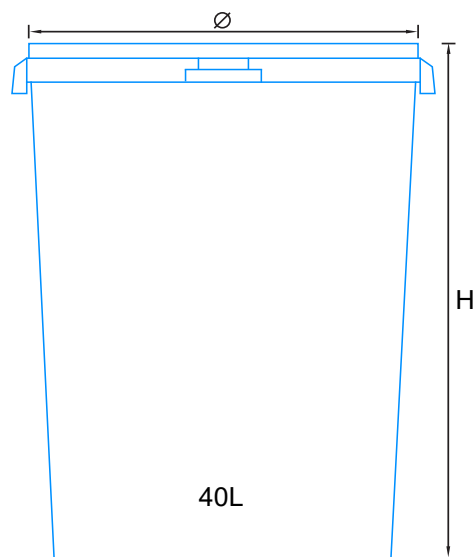

**WITHOUT HANDLE**



**WITH HANDLE**



**WITH 2 HANDLES**

Ref.	Ext. dim.	Cap. L		Qty./pallet
		Nominal	Total	
<b>9083_</b>	Ø120xH78mm	0,5	0,6	5500/ 
<b>9093_</b>	Ø120xH135mm	1	1,1	3300/ 
<b>911_ _</b>	Ø202xH218mm	5	5,2	800/  400/ 
<b>9123_</b>	Ø275xH247mm	10	10,3	480/  240/ 
<b>9713_</b>	Ø309xH275mm	15	15,5	396/  1m
<b>9133_</b>	Ø340xH335mm	20	23	288/  1m
<b>9222_</b>	Ø380xH510mm	40	44	180/  0.8m

## Oblong Bucket

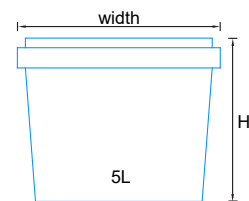
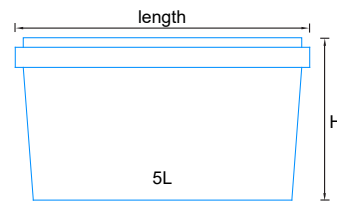

**WITH HANDLE**

Ref.	Ext. dim.	Cap. L		Qty./pallet
		Nominal	Total	
<b>9561_</b>	290x198x152mm <b>On request</b>	5	5,9	1000/ 

# TAMPER EVIDENT CONTAINERS WITH SNAP-ON CLOSURE











Suitable for food contact. Comply with the European food contact regulations.

The lids feature a tamper evident ring.



The containers are produced in white HDPE, and the lids in LDPE.

Ref.	Ext. dim.	Cap.	Qty./pallet
9470_	Ø68xH66mm	125cm <sup>3</sup>	2400/ 
9390_	Ø68xH194mm	250cm <sup>3</sup>	2160/ 
9370_	Ø100xH98mm	500cm <sup>3</sup>	1440/ 
9371_	Ø100xH118mm <i>On request</i>	650cm <sup>3</sup>	1440/ 
9372_	Ø100xH132mm <i>On request</i>	750cm <sup>3</sup>	1440/ 
9380_	Ø100xH161mm	1000cm <sup>3</sup>	1152/ 
9381_	Ø100xH181mm <i>On request</i>	1150cm <sup>3</sup>	1152/ 
9382_	Ø100xH195mm <i>On request</i>	1250cm <sup>3</sup>	1152/ 
9271_	Ø100xH242mm	2000cm <sup>3</sup>	1152/ 

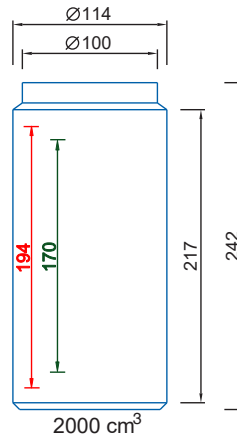
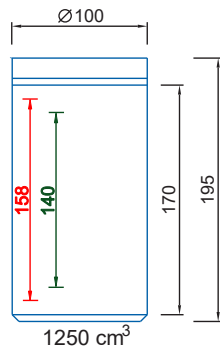
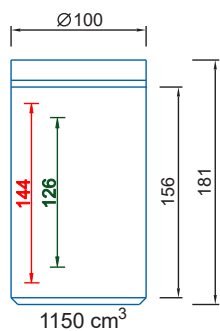
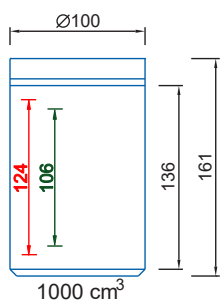
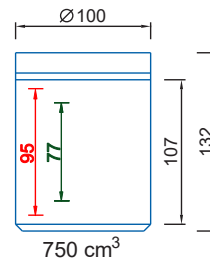
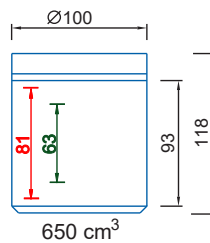
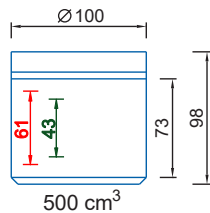
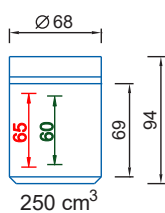
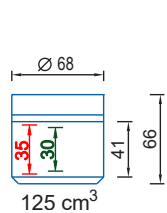

Label maximum height (mm)  
Screen printing maximum height (mm)

# WASTE SEPARATION BINS

## 60L Bins



## Waste Separation Bins

60L bin with pedal **Ref. 9580\_** available in:





- White, or:
- Grey with blue, yellow, green or light grey lid.

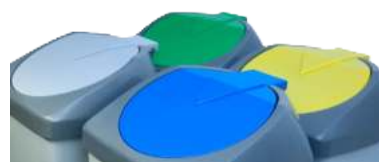

60L bin with push down lid **Ref. 9590\_** available in:

- Grey with blue, yellow, green or light grey lid.





Ref.	Ext. dim.	Cap.	Qty./pallet
<b>7880_</b>	680x450x120mm	60L	110/ 
<b>9570_</b>	585x435x360mm	60L	80/ 
<b>9580_</b>	730x430x400mm	60L	18/ 
<b>9590_</b>	680x435x345mm	60L	57/ 

## Flip-top Bins



On request: Silk Screen printing (up to 4 colours) available on lid and/or bin **Ref. 9224\_**.



Ref.	Ext. dim.	Cap.	Qty./pallet
<b>8901_</b>	390x200x200mm	8L	360/ 
<b>9224_</b>	90x420(Ø380)mm	40L	126/ 



## Bin without lid



8900\_  
□

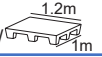

0230\_ 0240\_  
■ ■ ■ ■

Ref.	Ext. dim.	Cap.	Qty./pallet
8900_	295x195x195mm	8L	780/ 
0230_	217x160x290mm	6,2L	560/ 
0240_	217x255x290mm	13,5L	380/ 

Waste bin without lid Ref. 7900\_.

Waste bin with lid Ref. 7901\_.

Lid Ref. 7902\_ is available.



Ref. 7902\_  
■



## 80L Waste Bin



■ 7900\_



■ 7901\_

Ref.	Ext. dim.	Cap.	Qty./pallet
7900_	Ø480X670mm	80L	44/ 
7901_	Ø480X670mm	80L	40/ 

## Examples of use

### Urban Cleaning



PSAplast does not sell this trolley

# PALLET BOXES

Solid



Perforated



Lid 1,2x1m is available under Ref. **P794L\_**

Ref.	Skids	Ext. dim. (mm)	Int. dim. (mm)	Cap.	Ref.	Skids
<b>P742T0N_</b>	2	1200x1000x1200	1127x927x1044	1120	<b>P741T0N_</b>	2
<b>P742E0N_</b>	2-R	1200x1000x1200	1127x927x1044	1120	<b>P741E0N_</b>	2-R
<b>P742U0N_</b>	3	1200x1000x1200	1127x927x1044	1120	<b>P741U0N_</b>	3
<b>P742F0N_</b>	3-R	1200x1000x1200	1127x927x1044	1120	<b>P741F0N_</b>	3-R



Ref.	Skids	Ext. dim. (mm)	Int. dim. (mm)	Cap.	Ref.	Skids
<b>P744T0N_</b>	2	1200x1000x900	1121x921x744	800	<b>P743T0N_</b>	2
<b>P744E0N_</b>	2-R	1200x1000x900	1121x921x744	800	<b>P743E0N_</b>	2-R
<b>P744U0N_</b>	3	1200x1000x900	1121x921x744	800	<b>P743U0N_</b>	3
<b>P744F0N_</b>	3-R	1200x1000x900	1121x921x744	800	<b>P743F0N_</b>	3-R



Ref.	Skids	Ext. dim. (mm)	Int. dim. (mm)	Cap.	Ref.	Skids
<b>P746T0N_</b>	2	1200x1000x760	1119x919x604	650	<b>P745T0N_</b>	2
<b>P746E0N_</b>	2-R	1200x1000x760	1119x919x604	650	<b>P745E0N_</b>	2-R
<b>P746U0N_</b>	3	1200x1000x760	1119x919x604	650	<b>P745U0N_</b>	3
<b>P746F0N_</b>	3-R	1200x1000x760	1119x919x604	650	<b>P745F0N_</b>	3-R

R = Removable Skids (the strongest version)

**CENTRO** 2030

Os Fundos Europeus mais próximos de si.



**Cofinanciado pela  
União Europeia**