

180° TURN STACK & NESTING BOXES 9000 series

Solid Boxes



When empty they nest in each other to reduce the volume. Stacks by turning 180°.

The apertures below the handles facilitate the handling of the box.

The Lid Ref. 3006_ enables the use of security straps, for tamper evidence.



Ref. 3006_
(600 x 400 mm)

Ref.	Ext. dim.	Cap.	Qty./pallet
9901_	600x400x150mm	25L	195/
9701_	600x400x200mm	35L	190/
9751_	600x400x300mm	50L	130/
9801_	600x400x400mm	70L	90/



Ref. 9654_
Dolly
(600 x 400 mm)

Perforated Boxes

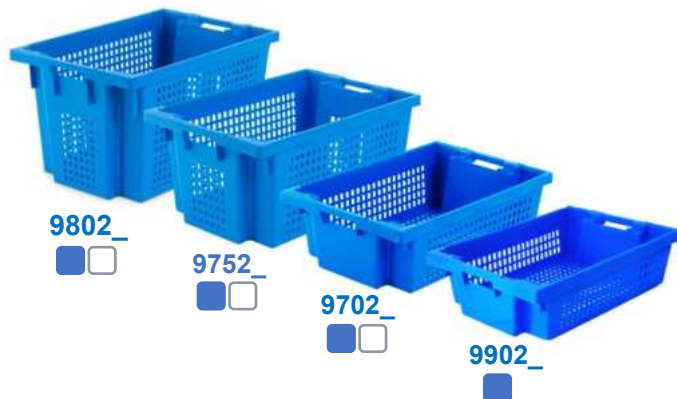

Ref. 9656_
Dolly
(600 x 400 mm)

Ref.	Ext. dim.	Cap.	Qty./pallet
9902_	600x400x150mm On request	25L	195/
9702_	600x400x200mm	35L	190/
9752_	600x400x300mm	50L	130/
9802_	600x400x400mm	70L	90/

On request, all models may be produced:

- with perforated walls and solid base, or:
- with solid walls and perforated base, or:
- with wheels, perforated walls and base (Ref. 990R, 970R, and 980R):
- with wheels, solid walls and perforated base.



980R_
■

180° TURN STACK & NESTING BOXES 9000 series

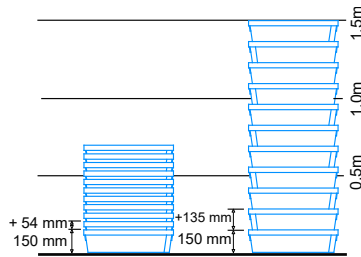

Ref. 990__
(ext.) 600x400x150mm
(int.) 490x332x145mm
25L



Ref. 970__
(ext.) 600x400x200mm
(int.) 490x332x195mm
35L

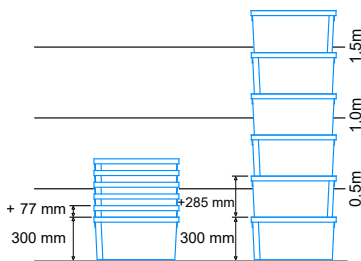
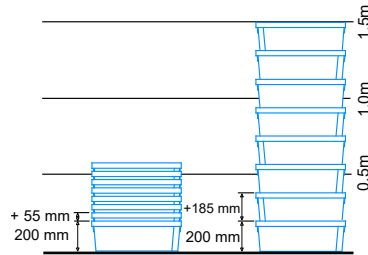

Ref. 975__
(ext.) 600x400x300mm
(int.) 490x332x295mm
50L



Ref. 980__
(ext.) 600x400x400mm
(int.) 490x332x395mm
70L

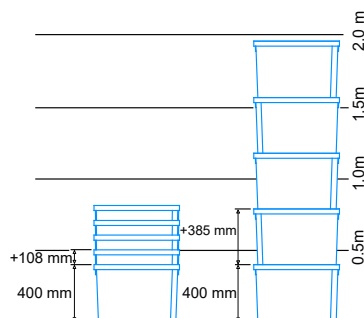

On request, all models may be produced:

- with perforated walls and solid base, or:
- with solid walls and perforated base, or:
- with wheels, perforated walls and base (Ref. 990R, 970R, and 980R):
- with wheels, solid walls and perforated base.

GRAPE HARVEST





The boxes are stackable. You may stack multiple boxes without crushing the grapes, preventing premature fermentation.

By turning the boxes 180°, they nest inside each other when empty, for ease of handling and space saving.

Lid and dolly available.

Solid Boxes



Ref.	Ext. dim.	Cap.	Qty./pallet
9901_	600x400x150mm	25L	195/ 
9701_	600x400x200mm	35L	190/ 
9751_	600x400x300mm	50L	130/ 

Printing on one side enables the user to distinguish between the stacking and the nesting positions:

- when stacked, the prints alternate.
- when nested, all the prints are on the same side

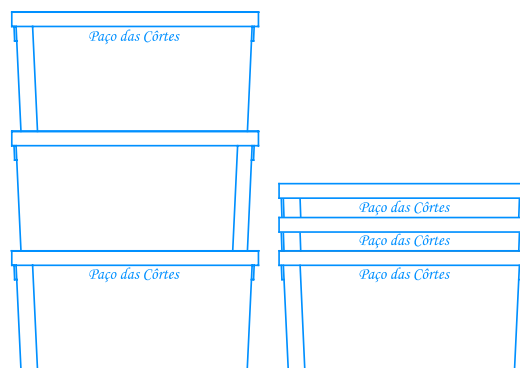

GRAPE HARVEST

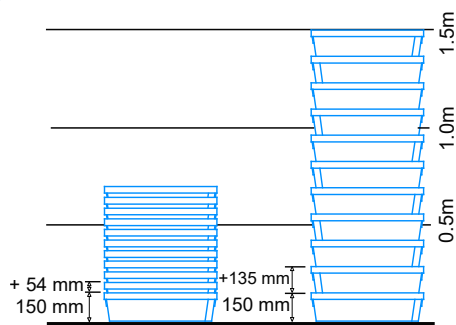

Ref. 990__
(ext.) 600x400x150mm
(int.) 490x332x145mm

25L
+/- 8 kg



Ref. 970__
(ext.) 600x400x200mm
(int.) 490x332x195mm

35L
+/- 12 kg

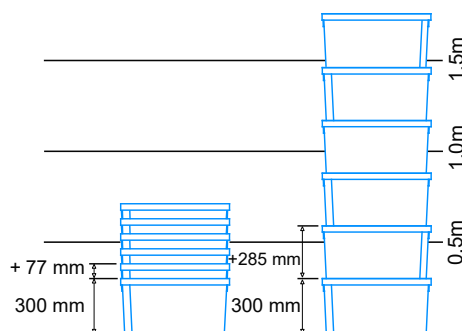
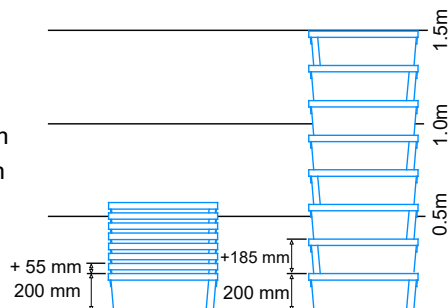

Ref. 975__
(ext.) 600x400x300mm
(int.) 490x332x295mm

50L
+/- 23 kg



The weights of grapes are a rough indication.

180° TURN STACK & NESTING BOXES 2000 series

Solid Boxes



2351_

2271_

When empty they nest in each other to reduce the volume. Stacks by turning 180°.

These 2000 Series boxes offer an increased internal volume when compared with other 180° turn stack & nesting boxes.

When fitting a **Lid Ref. 3006_** with security straps, tamper evidence is ensured because these boxes do not have apertures below the handles.



Ref. 3006_
(600 x 400 mm)





Ref. 9656_
Dolly
(600 x 400 mm)

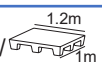

Ref. 9654_
Dolly
(600 x 400 mm)

Ref.	Ext. dim.	Cap.	Qty./pallet
2271_	600x400x270mm	50L	130/ 
2351_	600x400x350mm	66L	100/ 

Perforated Boxes

Ref.	Ext. dim.	Cap.	Qty./pallet
2272_	600x400x270mm <i>On request</i>	50L	130/ 
2352_	600x400x350mm <i>On request</i>	66L	100/ 



2353_

2273_

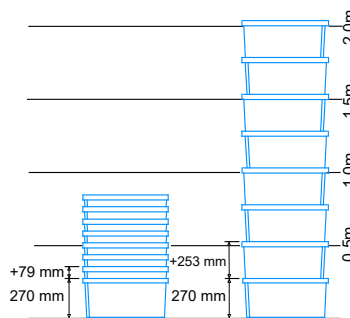

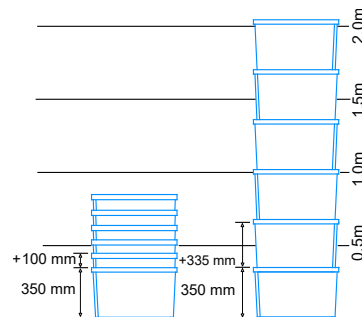

Ref. 227_ _
(ext.) 600x400x270mm
(int.) 490x340x267mm
50L

Ref. 235_ _
(ext.) 600x400x350mm
(int.) 490x340x347mm
66L



Boxes with solid base and perforated walls

Ref.	Ext. dim.	Cap.	Qty./pallet
2273_	600x400x270mm <i>On request</i>	50L	130/ 
2353_	600x400x350mm	66L	100/ 

On request all models may be produced:

- with solid base and perforated walls, or:
- with solid walls and perforated base, or:
- perforated.

ATTACHED LID BOXES 4000 series and 6000 series

Solid Boxes



Nest when empty.

Stack on the closed lids.

Enable the use of **security seals**, for tamper evidence.



Ref. 6402_
(without numbering)

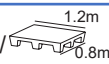
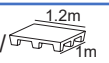
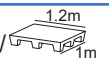
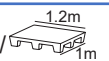

Ref. 6405_
(with sequential numbering)

Ref.	Ext. dim.	Cap.	Qty./pallet
4326_	400x300x265mm	22L	108/ 
4331_	400x300x310mm	25L	108/ 
6426_	600x400x265mm	48L	72/ 
6431_	600x400x310mm	54L	72/ 
6436_	600x400x365mm	65L	68/ 
6440_	600x400x400mm	70L	68/ 

Optional **ticket-window** available



Ref. 430J_

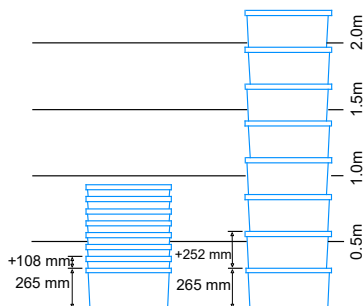

Ref. 4326_
(ext.) 400x300x265mm
(int.) 336x254x239mm
22L



Ref. 640J_

Ref. 4331_
(ext.) 400x300x310mm
(int.) 332x250x282mm
25L

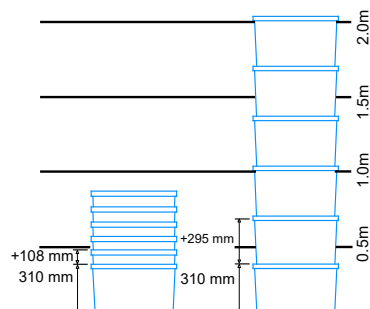

Ref. 9654_
Dolly
(600 x 400 mm)

ATTACHED LID BOXES 4000 series and 6000 series

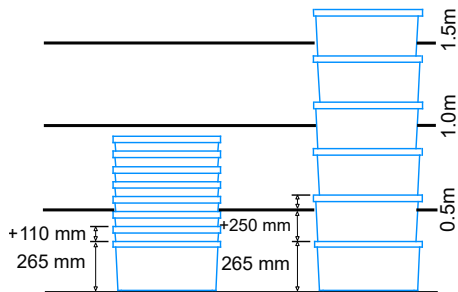

Ref. 6426_
(ext.) 600x400x260mm
(int.) 530x353x240mm

48L



Ref. 6431_
(ext.) 600x400x310mm
(int.) 514x350x281mm

54L

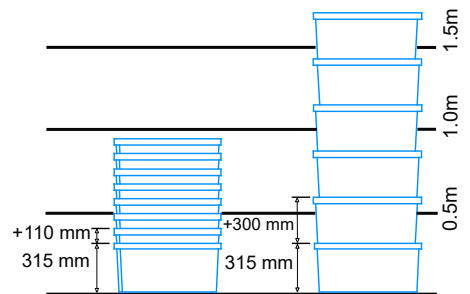

Ref. 6436_
(ext.) 600x400x365mm
(int.) 508x346x340mm

65L

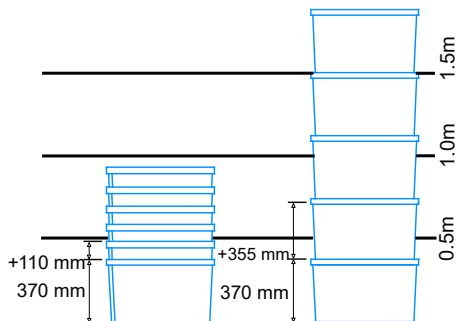

Ref. 6440_
(ext.) 600x400x400mm
(int.) 521x343x375mm

70L

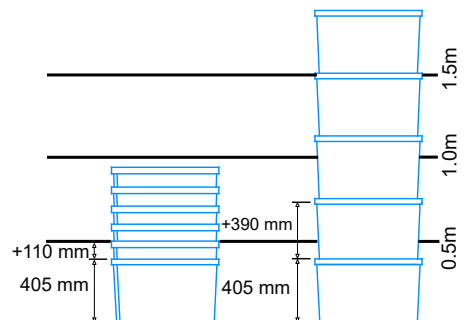

180° TURN STACK & NESTING BOXES 620x500mm 335_ series (100L)

Solid Box



3351_
■

Ref.	Ext. dim.	Cap.	Qty./pallet
3351_	620x500x403mm	100L	52/ 

When empty they nest in each other to reduce the volume. Stacks by turning 180°.

Designed to enable loading of 4 piles on 1,2x1,0m pallets.

When fitting a **Lid Ref. 0210_**, tamper evidence is ensured because these boxes do not have apertures below the handles.



Ref. 0210_
(620 x 500mm)

Box with solid base and perforated walls



3353_
■ □

Ref.	Ext. dim.	Cap.	Qty./pallet
3353_	620x500x403mm	100L	52/ 



Ref. 9652_
Dolly



Ref. 335_ _
(ext.) 620x500x403mm
(int.) 521x343x375mm
100L

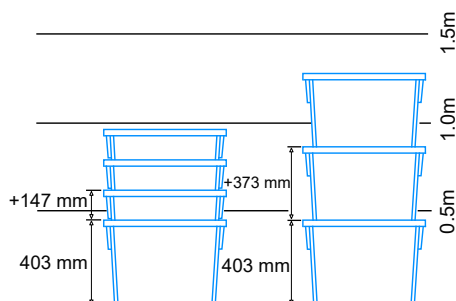

On request all models may be produced:

- perforated, or:
- with solid walls and perforated base.

STACKING BOXES



Originally developed for the cheese and pastry industries, they are also used for other applications requiring dimensions different from 600x400mm or 400x300mm.

The **Lid Ref. 7860_** is suitable for Ref. 7870_ and Ref. 7871_, and it enables stable stacking of one pile of Ref. 9280_ or 2 piles of Ref. 9015_.

Ref.	Ext. dim	Colour	Qty./pallet
7870_	680x450x120mm		80/
7871_	680x450x152mm		110/
9015_	435x300x95mm		300/
9280_	500x320x105mm		252/



Ref. 7860_
(680 x 450mm)

Perforated Box



332_

Solid Box



8470_



Ref. 9654_
Dolly
(600 x 400 / 680 x 450 mm)

Ref.	Ext. dim.	Colour	Qty./pallet
332_	500x310x255mm		84/
8470_	400x300x170mm		130/

Originally developed as a **fish box**, it is also used for many other applications which require specific dimensions different from 600x400mm.

The drainage holes in the box are designed to ensure that liquids drain along the outer walls of the boxes below, preventing contamination by liquids from the boxes above.

Its design enables staggered stacking in order to optimise the use of space in the hulls of fishing boats.

Fish Box



9500_

Ref.	Ext. dim.	Colour	Qty./pallet
9500_	725x485x130mm		54/



STACKING BOXES

Versatile box, ideal for use in the food industry and for hand luggage inspection at airports.



9450_



Ref.	Ext. dim.	Colour	Qty./pallet
9450_	540x380x80mm	<input type="checkbox"/>	750/ 



The grid may also be sold separately under **Ref. 9452_**.

Tray with grids



9451_

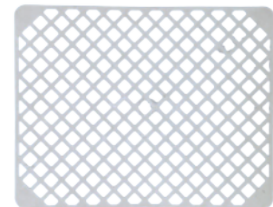

The grids **Ref. 9452_** are also compatible with the 9000 series boxes.

Ref.	Ext. dim.	Colour	Qty./pallet
9451_	540x380x80mm	<input type="checkbox"/>	750/ 



9901_
and
9452_



BALE-ARM STACK & NESTING BOXES 1000 series

Solid Boxes



1301_
■

1201_
■

Ref.	Ext. dim.	Cap.	Qty./pallet
1201_	600x400x200mm On request	35L	140/ 
1301_	600x400x300mm	53L	130/ 

Stack, and also nest when empty to minimize the volume.

The bale-arm stacking design maximizes the internal volume. Includes label holders on the 2 short ends.

Lid and dollies available.



Ref. 3006_
(600 x 400 mm)



Ref. 9654_
Dolly
(600 x 400 mm)



Ref. 9656_
Dolly
(600 x 400 mm)

Perforated Boxes



1302_
■

1202_
■

Ref.	Ext. dim.	Cap.	Qty./pallet
1202_	600x400x200mm	35L	140/ 
1302_	600x400x300mm	53L	130/ 

All models may be produced with perforated walls and solid base, or vice-versa.

Ref. 120_
(ext.) 600x400x200mm
(int.) 530x340x172mm

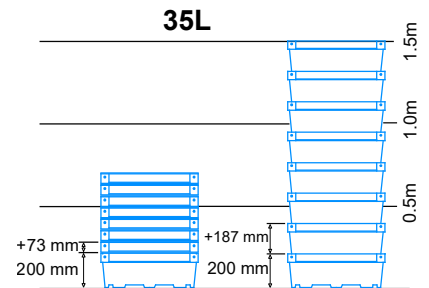

Ref. 130_
(ext.) 600x400x300mm
(int.) 530x340x272mm

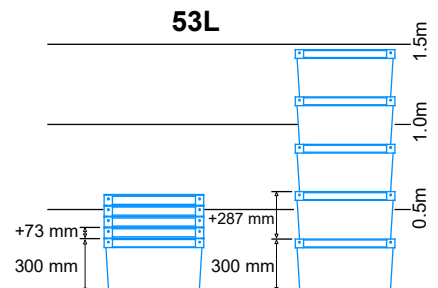

800x600mm FOLDING BOXES 962_ series



Stackable and foldable when empty to minimize the volume.

The Lid Ref. 9635_ enables the use of security seals, for tamper evidence.











Ref. 9635_
(800 x 600 mm)

The boxes may be stacked on each other or over the lids, with or without castor wheels.

The box with drop-doors Ref. 9625_ enables side access. The box is also available with side aperture (without doors) Ref. 9628_.

Boxes with open base may be stacked on other boxes to increase the internal height.

Ref.	Features	Kg	Qty./pallet
9620_	Open base	6,72	36/ 
9621_	Solid base	8,28	36/ 
9622_	Solid base and castor wheels	10,38	20/ 
9625_	Drop doors	8,28	36/ 
9626_	Drop doors & wheels	10,38	20/ 
9628_	With side aperture	7,68	36/ 
9629_	With side aperture & wheels	9,78	20/ 
962P_	With doors & open base	6,78	36/ 

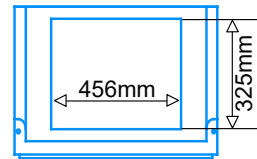

Does not include the handles shown in the pictures (each handle is sold separately under Ref. 9636_).



Ref. 9636_ 

Handles

Ref. 962_ _

(ext.) 800x600x465mm
(int.) 760x560x450mm

183L

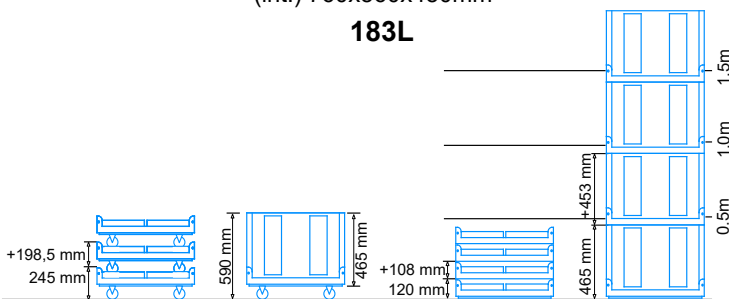

BALE-ARM PICKING BOXES

1000 series

Boxes with aperture on the short side



Ref.	Ext. dim.	Cap.	Qty./pallet
120P_	600x400x200mm <i>On request</i>	35L	140/
1305_	600x400x300mm	53L	130/
1306_	600x400x300mm	53L	130/
130P_	600x400x300mm	53L	130/
130Q_	600x400x300mm	53L	130/

Stack, and also nest when empty to minimize the volume.

The bale-arm stacking design maximizes the internal volume. Includes label holders on the 2 short ends.



Ref. 3006_
(600 x 400 mm)



Ref. 9654_
Dolly
(600 x 400 mm)



Ref. 9656_
Dolly
(600 x 400 mm)

Boxes with aperture on one long wall



Ref.	Ext. dim.	Cap.	Qty./pallet
130R_	600x400x300mm	53L	130/
130T_	600x400x300mm	53L	130/

Ref. 1305_ e 1306_
600x400x300mm
53L

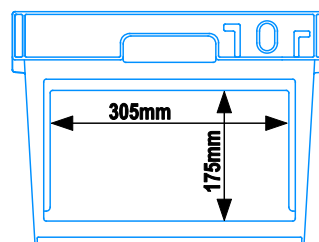

Ref. 130P_ ou Ref. 130Q_
600x400x300mm
53L

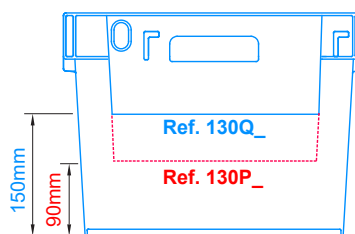

All models may be produced with perforated walls and solid base, or vice-versa.

FOLDING PICKING BOXES





800x600mm Folding Picking Boxes

Stack, and also nest when empty to minimize the volume.



Ref. 9625_



Ref.	Features	Cap.	Qty./pallet
9625_	Drop doors	183L	36/ 
9626_	Drop doors & wheels	183L	20/ 
9628_	With side aperture	183L	36/ 
9629_	With side aperture & wheels	183L	20/ 
9635_	Lid		80/ 

Does not include the handles shown in the pictures (each handle is sold separately under Ref. 9636_).



Ref. 9636_
Handles

Ref. 962_
(ext.) 800x600x465mm
(int.) 760x560x450mm
183L

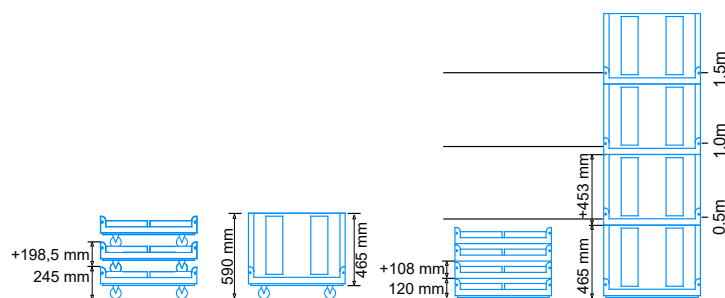

Lid Ref. 9635_ is available





Ref. 9635_
(800 x 600 mm)

TRAYS FOR THE AGRICULTURE AND FOOD INDUSTRIES 961_ series

Perforated





9610_ 9611_ 9612_

Ref.	Ext. dim.	Version	Qty./pallet
9610_	600x400x59mm On request	Without Corners	190/ 
9611_	600x400x77mm On request	With low Corners	145/ 
9612_	600x400x92mm	With high Corners	100/ 

Solid



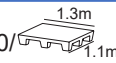
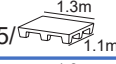

9613_ 9614_ 9615_

Ref.	Ext. dim.	Version	Qty./pallet
9613_	600x400x59mm On request	Without Corners	190/ 
9614_	600x400x77mm On request	With low Corners	145/ 
9615_	600x400x92mm	With high Corners	100/ 

Solid Base, Perforated Walls



9616_ 9617_ 9618_

Ref.	Ext. dim.	Version	Qty./pallet
9616_	600x400x59mm	Without Corners	190/ 
9617_	600x400x77mm	With low Corners	145/ 
9618_	600x400x92mm On request	With high Corners	100/ 

Stacking trays suitable for transport and storage of a wide range of products (bread, pastry, cheese, meat, hamburgers, pasta, fruit, vegetables, etc.).

Lid and dolly available.



Ref. 3006_ (600 x 400 mm)



Ref. 9654_ Dolly (600 x 400 mm)

On request another 3 models not presented by the photos may be produced:

- with solid walls, perforated base without corners, or:
- with solid walls, perforated base with low corners, or:
- with solid walls, perforated base with high corners.

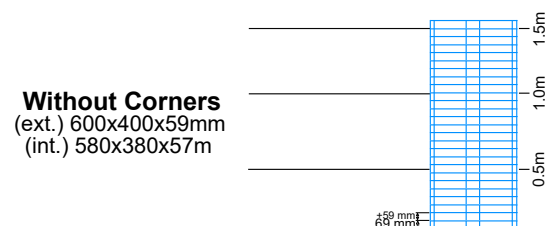
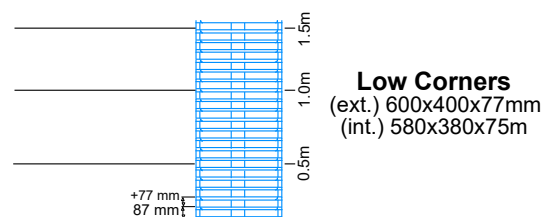
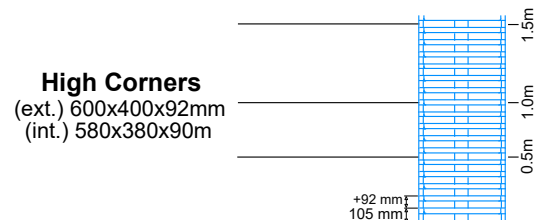

On request: Marking with your company's name, address or logo.

Pallets



2281_

Ref. 2281_ Load (Kg)	
Static	Dynamic
1000	800

Ref.	Ext. dim.	KG	Qty./pallet
2281_	1200x800x150mm	6,9	50/ 

This pallet is suitable for food contact.

Pallet **Ref. 2281_** is not suitable for racking. With 9 feet (no skids). Nests to save space.

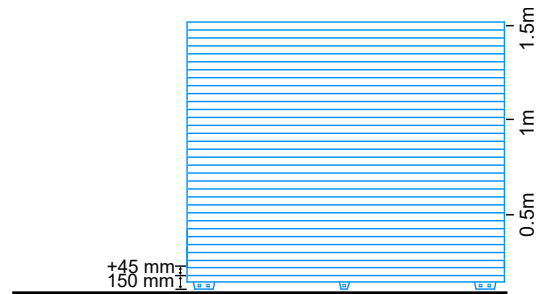

TAMPER EVIDENT BUCKETS & OBLONG BUCKET

Tamper Evident Buckets



White, or transparent base with white lid



White

Suitable for food contact. Comply with the European food contact regulations.

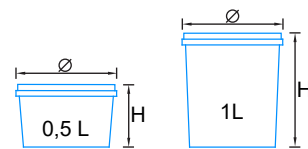



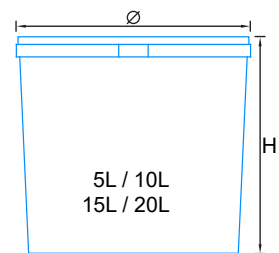



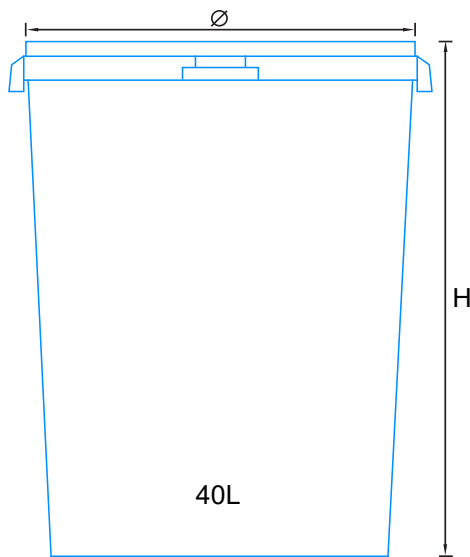

WITHOUT HANDLE



WITH HANDLE



WITH 2 HANDLES

Ref.	Ext. dim.	Cap. L		Qty./pallet
		Nominal	Total	
9083_	Ø120xH78mm	0,5	0,6	5500/ 
9093_	Ø120xH135mm	1	1,1	3300/ 
911_ _	Ø202xH218mm	5	5,2	800/  400/ 
9123_	Ø275xH247mm	10	10,3	480/  240/ 
9713_	Ø309xH275mm	15	15,5	396/  1m
9133_	Ø340xH335mm	20	23	288/  1m
9222_	Ø380xH510mm	40	44	180/  0.8m

Oblong Bucket

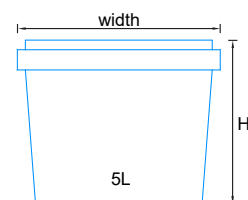
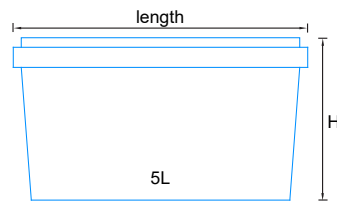

WITH HANDLE

Ref.	Ext. dim.	Cap. L		Qty./pallet
		Nominal	Total	
9561_	290x198x152mm On request	5	5,9	1000/ 

TAMPER EVIDENT CONTAINERS WITH SNAP-ON CLOSURE



Suitable for food contact. Comply with the European food contact regulations.

The lids feature a tamper evident ring.

Ref.	Ext. dim.	Cap.	Qty./pallet
9470_	Ø68x \underline{A} 66mm	125cm ³	2400/ 
9390_	Ø68x \underline{A} 194mm	250cm ³	2160/ 
9370_	Ø100x \underline{A} 98mm	500cm ³	1440/ 
9372_	Ø100x \underline{A} 132mm On request	750cm ³	1440/ 
9380_	Ø100x \underline{A} 161mm	1000cm ³	1152/ 
9271_	Ø100x \underline{A} 242mm	2000cm ³	1152/ 



The containers are produced in white HDPE, and the lids in LDPE.

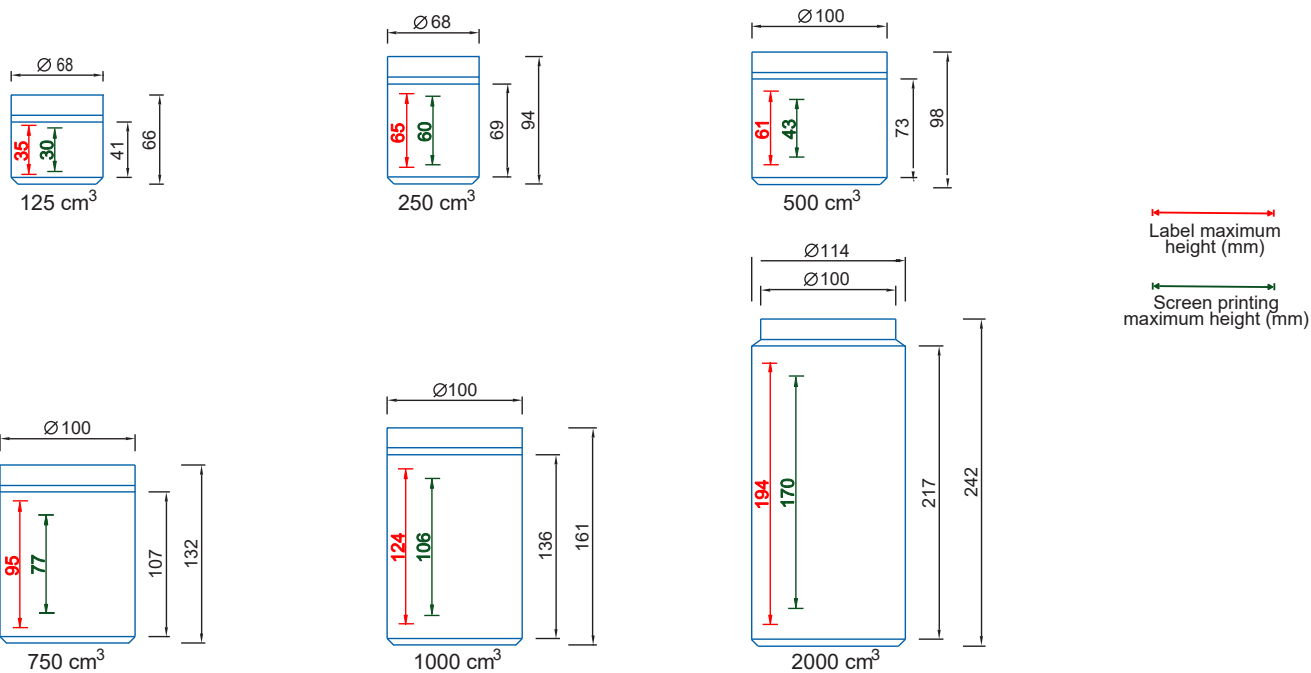

WASTE SEPARATION BINS

60L Bins



Waste Separation Bins

60L bin with pedal **Ref. 9580_** available in:





- White, or:
- Grey with blue, yellow, green or light grey lid.

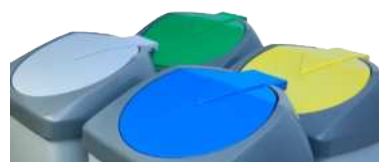

60L bin with push down lid **Ref. 9590_** available in:

- Grey with blue, yellow, green or light grey lid.





Ref.	Ext. dim.	Cap.	Qty./pallet
7880_	680x450x120mm	60L	110/ 
9570_	585x435x360mm	60L	80/ 
9580_	730x430x400mm	60L	18/ 
9590_	680x435x345mm	60L	57/ 

Flip-top Bins



On request: Silk Screen printing (up to 4 colours) available on lid and/or bin **Ref. 9224_**.



Ref.	Ext. dim.	Cap.	Qty./pallet
8901_	390x200x200mm	8L	360/ 
9224_	90x420(Ø380)mm	45L	126/ 

WASTE SEPARATION BINS / 80L WASTE BIN

Bin without lid



8900_
□



0230_ 0240_
■ ■ ■ ■



Waste bin without lid **Ref. 7900_**.

Waste bin with lid **Ref. 7901_**.

Lid **Ref. 7902_** is available.



Ref. 7902_
■

Ref.	Ext. dim.	Cap.	Qty./pallet
8900_	295x195x195mm	8L	780/ 
0230_	217x160x290mm	6,2L	560/ 
0240_	217x255x290mm	13,5L	380/ 

80L Waste Bin



■ **7900_**





■ **7901_**

Examples of use

Urban Cleaning



PSAplast does not sell this trolley

Ref.	Ext. dim.	Cap.	Qty./pallet
7900_	Ø480X670mm	80L	44/ 
7901_	Ø480X670mm	80L	40/ 

PALLET BOXES

Solid



Perforated



Lid 1,2x1m is available under Ref. **P794L_**

Ref.	Skids	Ext. dim. (mm)	Int. dim. (mm)	Cap.	Ref.	Skids
P742T0N_	2	1200x1000x1200	1127x927x1044	1120	P741T0N_	2
P742E0N_	2-R	1200x1000x1200	1127x927x1044	1120	P741E0N_	2-R
P742U0N_	3	1200x1000x1200	1127x927x1044	1120	P741U0N_	3
P742F0N_	3-R	1200x1000x1200	1127x927x1044	1120	P741F0N_	3-R



Ref.	Skids	Ext. dim. (mm)	Int. dim. (mm)	Cap.	Ref.	Skids
P744T0N_	2	1200x1000x900	1121x921x744	800	P743T0N_	2
P744E0N_	2-R	1200x1000x900	1121x921x744	800	P743E0N_	2-R
P744U0N_	3	1200x1000x900	1121x921x744	800	P743U0N_	3
P744F0N_	3-R	1200x1000x900	1121x921x744	800	P743F0N_	3-R



Ref.	Skids	Ext. dim. (mm)	Int. dim. (mm)	Cap.	Ref.	Skids
P746T0N_	2	1200x1000x760	1119x919x604	650	P745T0N_	2
P746E0N_	2-R	1200x1000x760	1119x919x604	650	P745E0N_	2-R
P746U0N_	3	1200x1000x760	1119x919x604	650	P745U0N_	3
P746F0N_	3-R	1200x1000x760	1119x919x604	650	P745F0N_	3-R

R = Removable Skids (the strongest version)

CENTRO 2030

Os Fundos Europeus mais próximos de si.



**Cofinanciado pela
União Europeia**